

HILAL GEMI

HILAL GEMI MUHENDISLIK
ELEKTRIK DONATIM VE OTOMASYON
AYDINTEPE M. SEHIT MURAT MATUZ S. NO:10/ATUZLA/ISTANBUL
TEL: 0216 395 60 50 FAKS 0216 395 77 60
www.hilalgemi.com info@hilalgemi.com

CUSTOMER : BESIKTAS TERSANE A. S.

PROJECT CODE : BSK/HLL-YH05

CLASS : RINA

PRODUCER (FIRM) : HILAL GEMI MUHENDISLIK

PROJECT NAME : YUZER HAVUZ-3 ADP SANCAK 400VAC

DESIGNED BY : YUSUF BAK











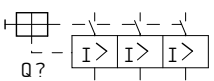

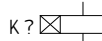



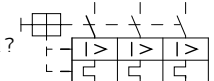

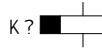

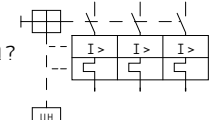
DRAWN BY : SULEYMAN SANCAK

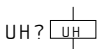
CHECKED BY : BASAR DENIZ

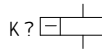
HIGHEST PAGE NUMBER : 63

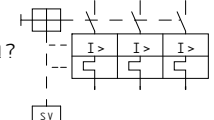
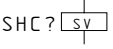
PAGE NUMBER : 63

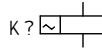
 HILAL GEMI MUHENDISLIK ELEKTRIK DONANIM VE OTOMASYON SAN. TIC. LTD. STI Giptas San. Sitesi B/Blok No:30 Icmeler/TUZLA Tel: 0216 395 60 50 GSM: 0539 648 88 05 www.hilalgemi.com	DATE	SANCAK ADP 400VAC	BESIKTAS SHIPYARD	YUZER HAVUZ 3	=		
	DRAWN BY				+		
	CHECKED BY						
				PROJE KOD	BSK/HLL-YH32	Page Number	1
				CLASS	RINA	Highest Page Number	63

<p>CIRCUIT BREAKER WITH SHORTCIRCUIT TRIP</p> 	<p>FUSE</p> 	<p>TIME RELAY</p> 	<p>FREQUENCYMETER</p> 	<p>TRANSFORMER</p> 
				<p>CURRENT TRANSFORMER</p> 
<p>CIRCUIT BREAKER WITH SHORTCIRCUIT-OVERCURRENT TRIP</p> 	<p>FUSE</p> 	<p>CONTACTOR WITH TIME RELAY</p> 	<p>KILOWATTMETER</p> 	
<p>CIRCUIT BREAKER WITH UNDERVOLTAGE RELAY</p> 		<p>CONTACTOR WITH UNDERVOLTAGE RELAY</p> 		<p>PUSH BUTTON</p> 
<p>UNDERVOLTAGE RELAY</p> 	<p>FUSE TERMINAL</p> 	<p>DC RELAY</p> 	<p>VOLTMETER</p> 	<p>PUSH BUTTON</p> 
<p>CIRCUIT BREAKER WITH SHUNT RELAY</p> 				
<p>SHUNT RELAY</p> 	<p>CONTACTOR COIL</p> 	<p>AC RELAY</p> 	<p>AMMETER</p> 	<p>INDICATING LAMP</p> 

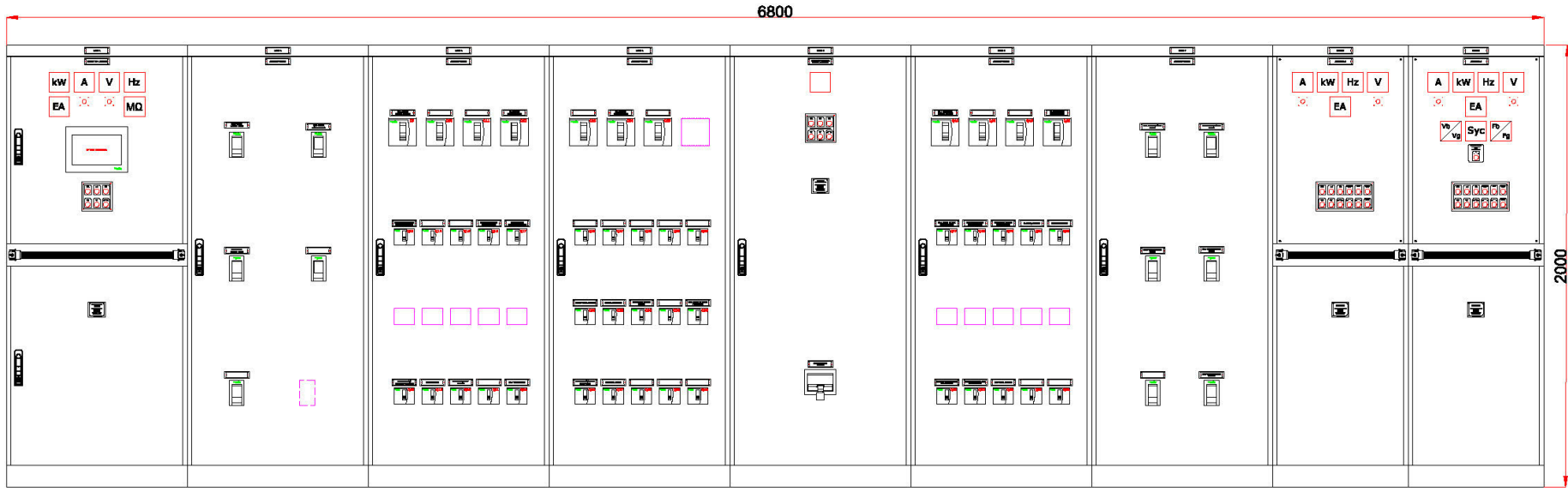

PANO FOUNDATION GÖRÜNÜŞÜ

 HILAL GEMİ MUHENDİSLİK ELEKTRİK DONANIM VE OTOMASYON SAN. TİC. LTD. STİ Gıptas San. Sitesi B/Blok No:30 İcmeler/TUZLA Tel:0216 395 60 50 GSM:0539 648 88 05 www.hilalgemi.com	DATE	SANCAK ADP 400VAC GENEL GORUNUS	BESIKTAS SHIPYARD	YUZER HAVUZ 3	=	
	DRAWN BY			PROJE KOD	BSK/HLL-YH32	Page Number
	CHECKED BY			CLASS	RINA	Highest Page Number

1221

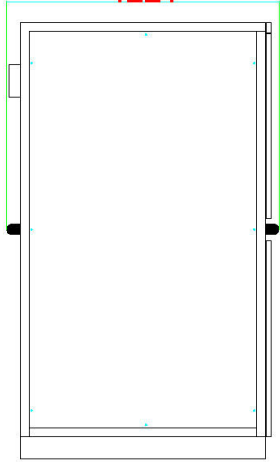
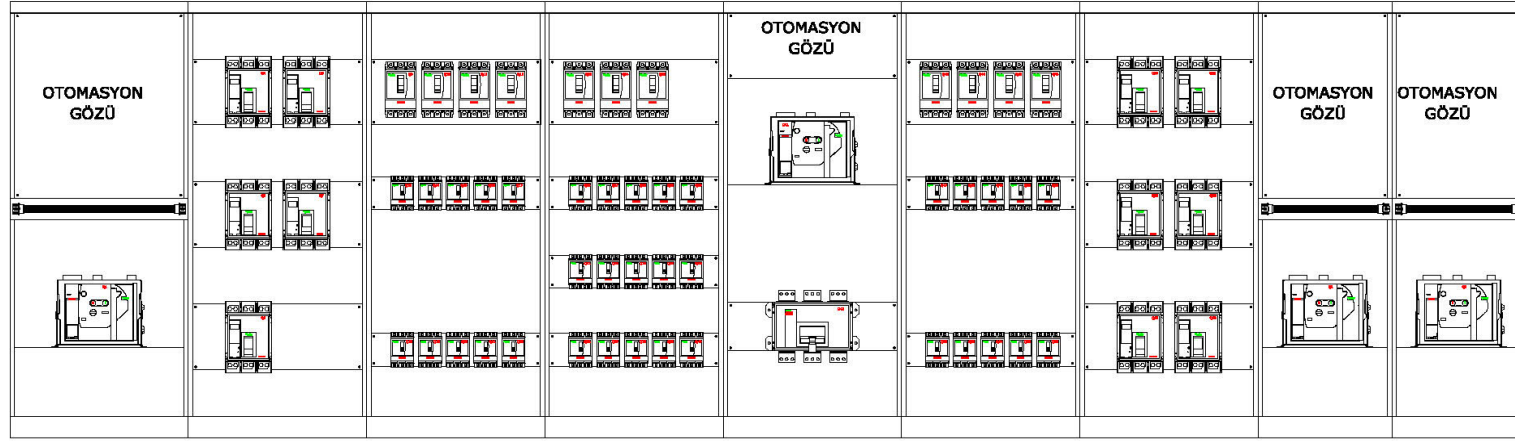
PANO YAN
GÖRÜNÜŞ

PANO İÇ GÖRÜNÜŞ

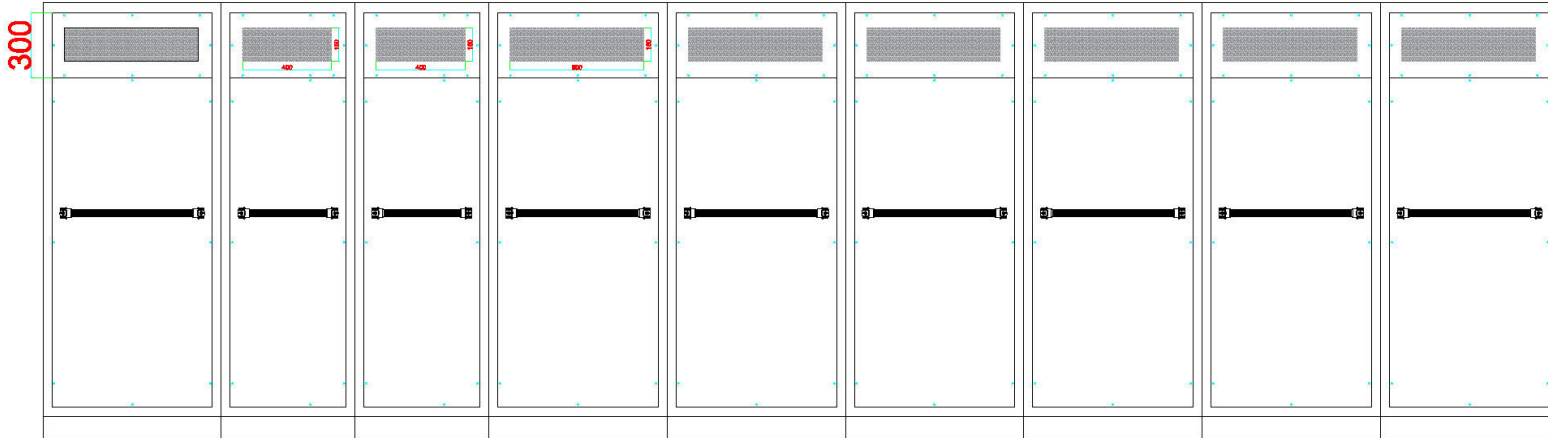

PANO ARKA GÖRÜNÜŞ

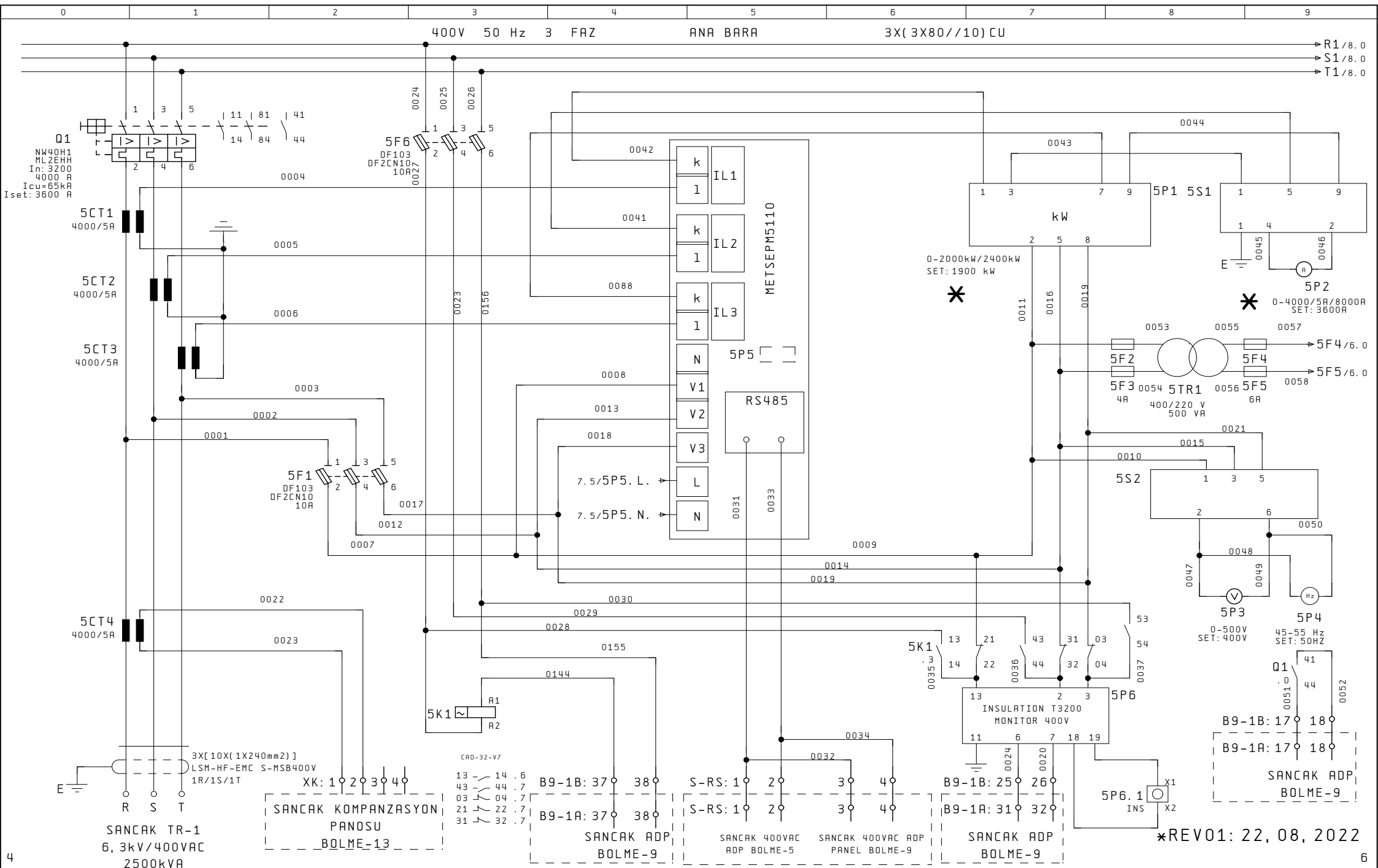

*REV01: 22, 08, 2022

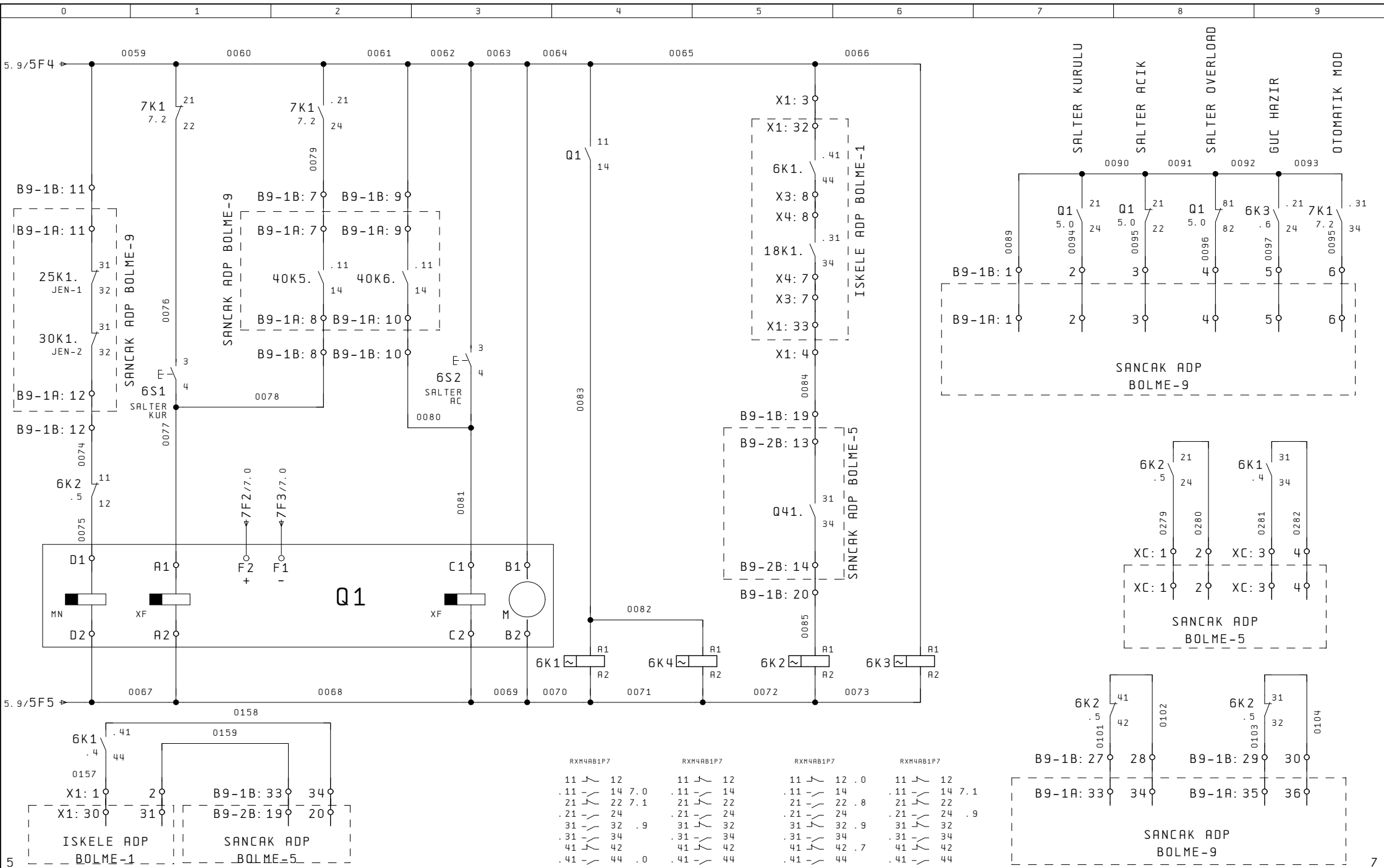

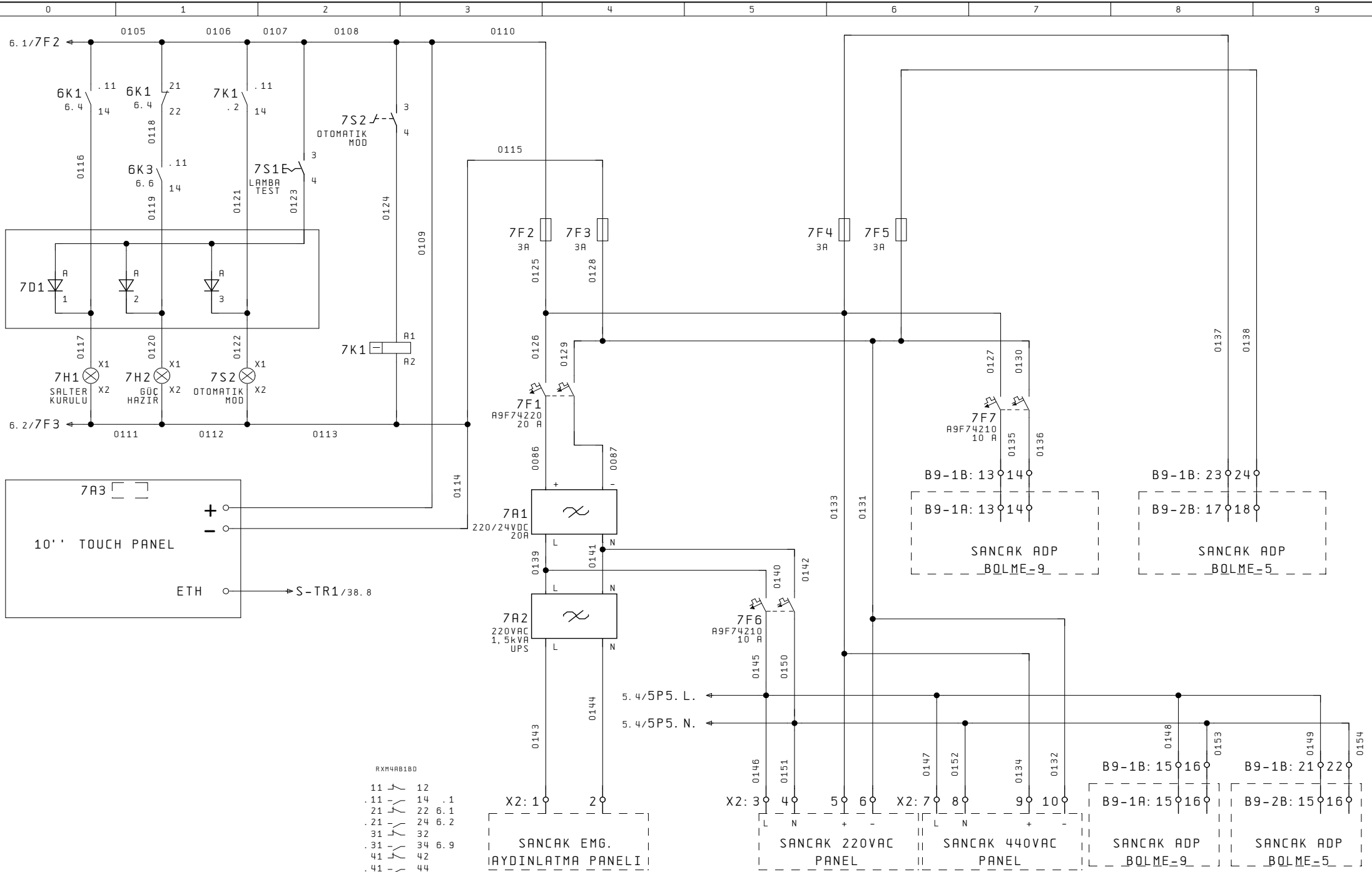

RXM4AB180

- 11 12
- .11 14 .1
- 21 22 6.1
- .21 24 6.2
- 31 32
- .31 34 6.9
- 41 42
- .41 44



DATE	
DRAWN BY	
CHECKED BY	

SANCAK ADP PANO BOLME-1

BESIKTAS SHIPYARD

YUZER HAVUZ 3	
PROJE KOD	BSK/HLL-YH32
CLASS	RINA

Page Number	7
Highest Page Number	63

3X(3X80//10) CU

5.9/R1 → R1.1/9.0
5.9/S1 → S1.1/9.0
5.9/T1 → T1.1/9.0

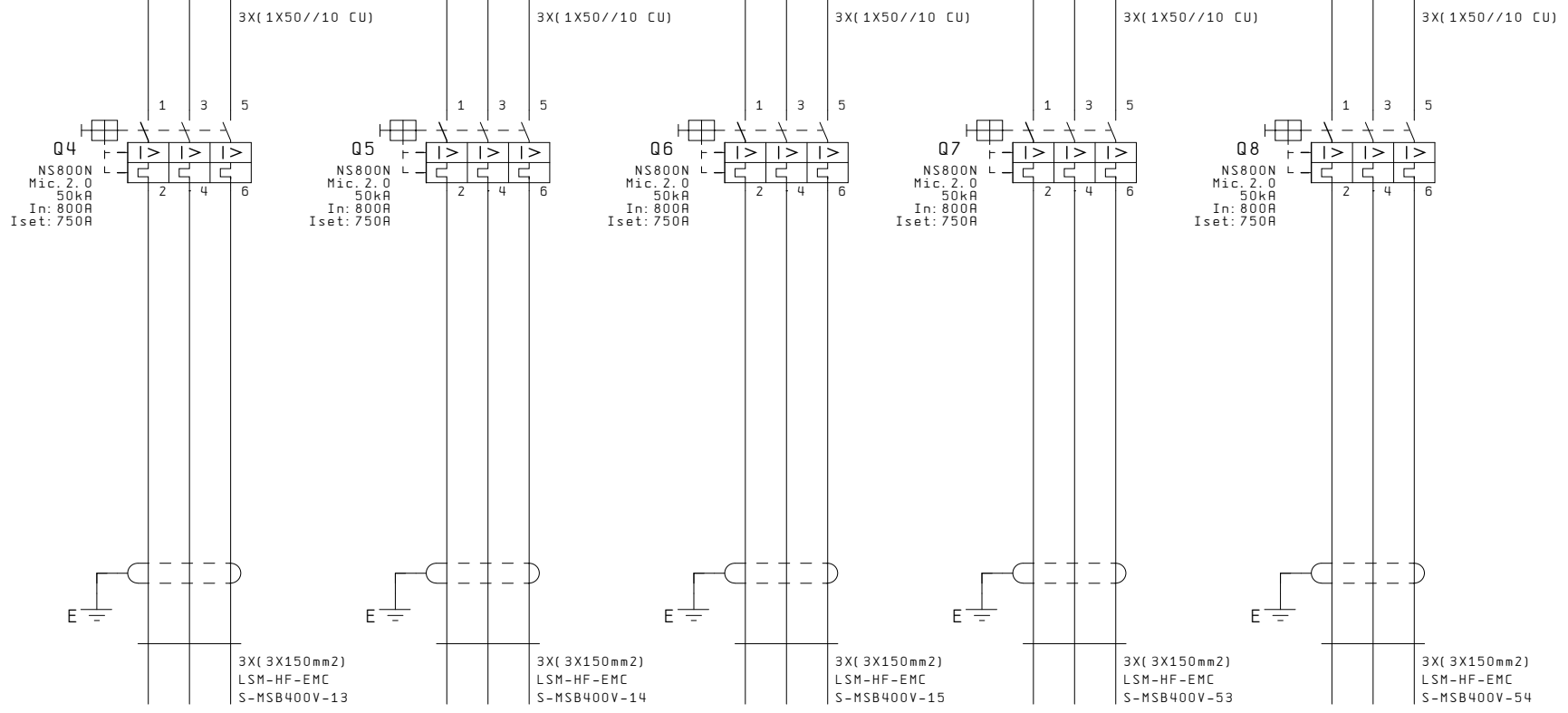

NO.5 400VAC
DAGITIM PANELI

NO.6 400VAC
DAGITIM PANELI

NO.7 400VAC
DAGITIM PANELI

YEDEK

YEDEK

3X(3X80//10) CU

8.9/R1.1 → R1.2/10.0
8.9/S1.1 → S1.2/10.0
8.9/T1.1 → T1.2/10.0

3X(1X30//10) CU

3X(1X30//10) CU

3X(1X30//10) CU

3X(1X30//10) CU

Q9
NSX400N
Mic: 2,3
50kA
In: 400A
Iset: 250A

Q10
NSX400N
Mic: 2,3
50kA
In: 400A
Iset:

Q11
NSX400N
Mic: 2,3
50kA
In: 400A
Iset:

Q12
NSX400N
Mic: 2,3
50kA
In: 400A
Iset: 250A

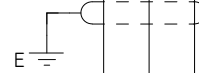
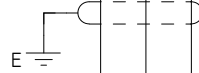
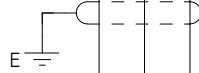
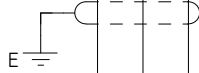

3X120mm2
LSM-HF-EMC
S-MSB400V-19

3X120mm2
LSM-HF-EMC
S-MSB400V-55

3X120mm2
LSM-HF-EMC
S-MSB400V-56

3X120mm2
LSM-HF-EMC
S-MSB400V-20

NO. 1 SU JETI
110kW

YEDEK

YEDEK

NO. 2 SU JETI
110kW

 HILAL GEMİ MUHENDİSLİK ELEKTRİK DONANIM VE OTOMASYON SAN. TİC. LTD. STİ Gıptas San. Sitesi B/Blok No:30 İçmeler/TUZLA Tel:0216 395 60 50 GSM:0539 648 88 05 www.hilalgemi.com	DATE	SANCAK ADP PANO 400VAC TUKETİM BOLME-3	BESIKTAS SHIPYARD	YUZER HAVUZ 3	=	
	DRAWN BY			PROJE KOD	BSK/HLL-YH32	Page Number 9
CHECKED BY				CLASS	RINA	Highest Page Number 63

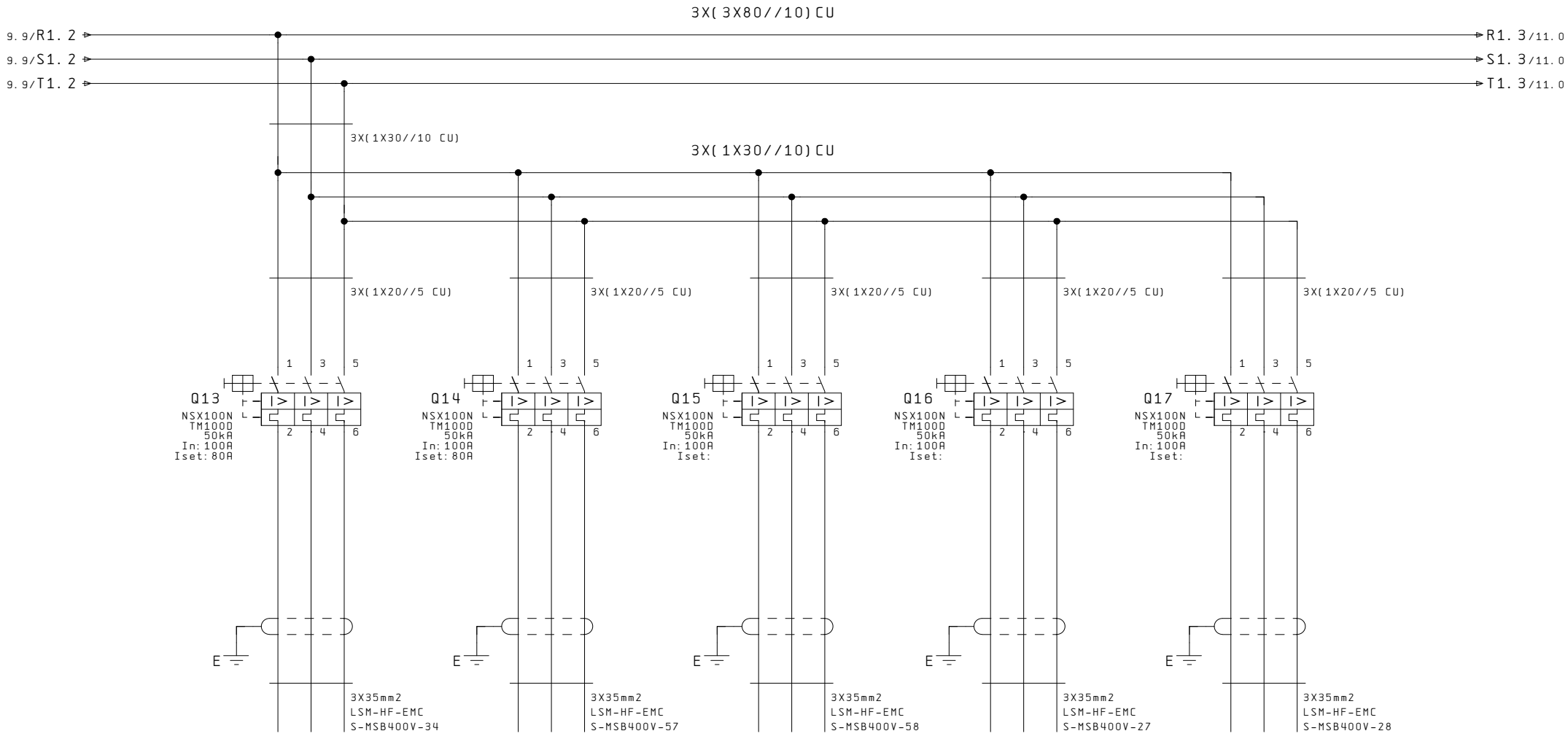

NO. 5 HAVUZ
BORDA PRIZ
PANOSU

YEDEK

YEDEK

NO. 5 HAVUZ
ICI PRIZ
PANOSU

NO. 6 HAVUZ
ICI PRIZ
PANOSU

 <p>HILAL GEMİ MUHENDİSLİK ELEKTRİK DONANIM VE OTOMASYON SAN. TİC. LTD. STİ Gıptas San. Sitesi B/Blok No:30 İcmeler/TUZLA Tel:0216 395 60 50 GSM:0539 648 88 05 www.hilalgemi.com</p>	DATE	SANCAK ADP PANO 400VAC TUKETİM BOLME-3	BESIKTAS SHIPYARD	YUZER HAVUZ 3		=
	DRAWN BY			PROJE KOD	BSK/HLL-YH32	Page Number
CHECKED BY			CLASS	RINA	Highest Page Number	63

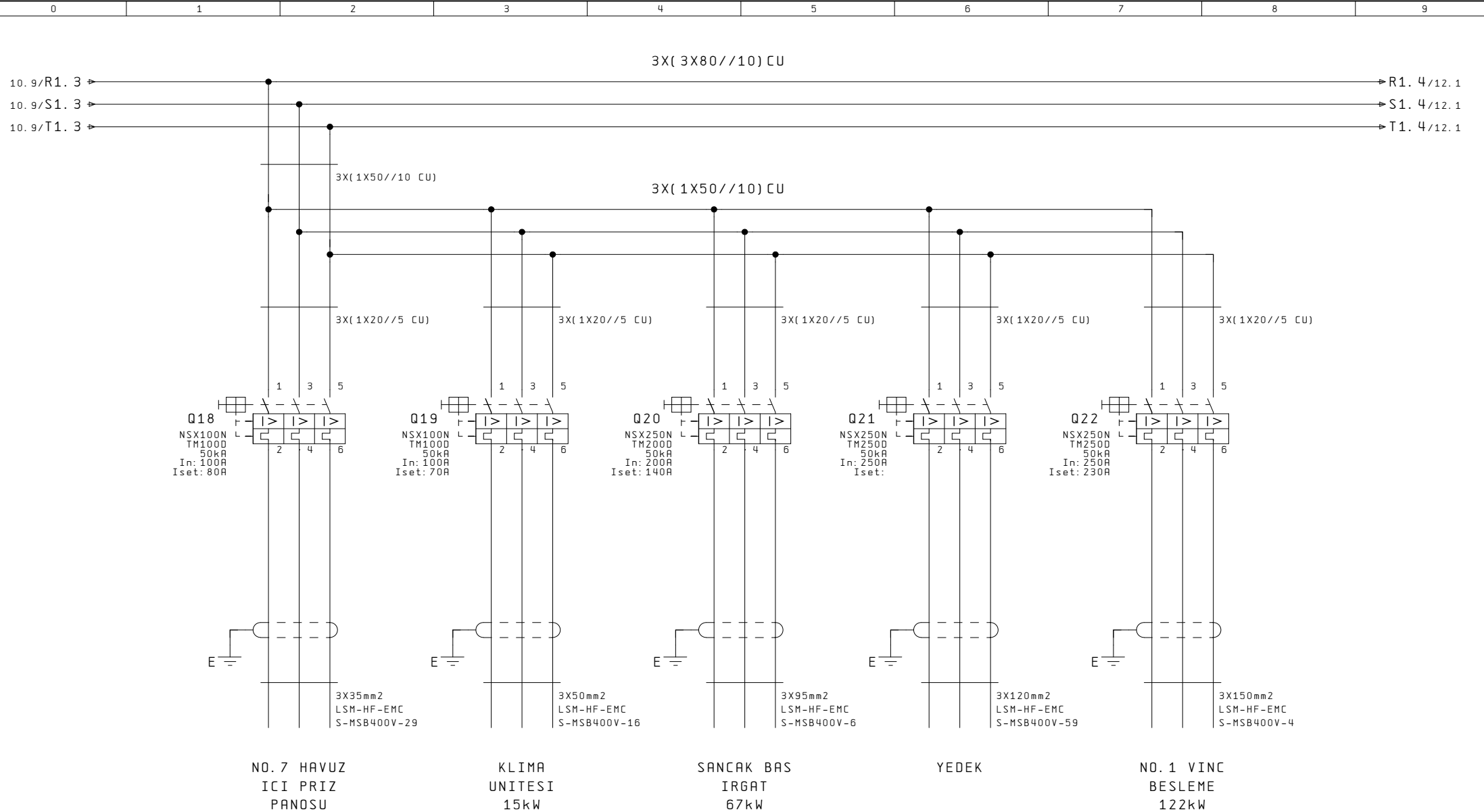

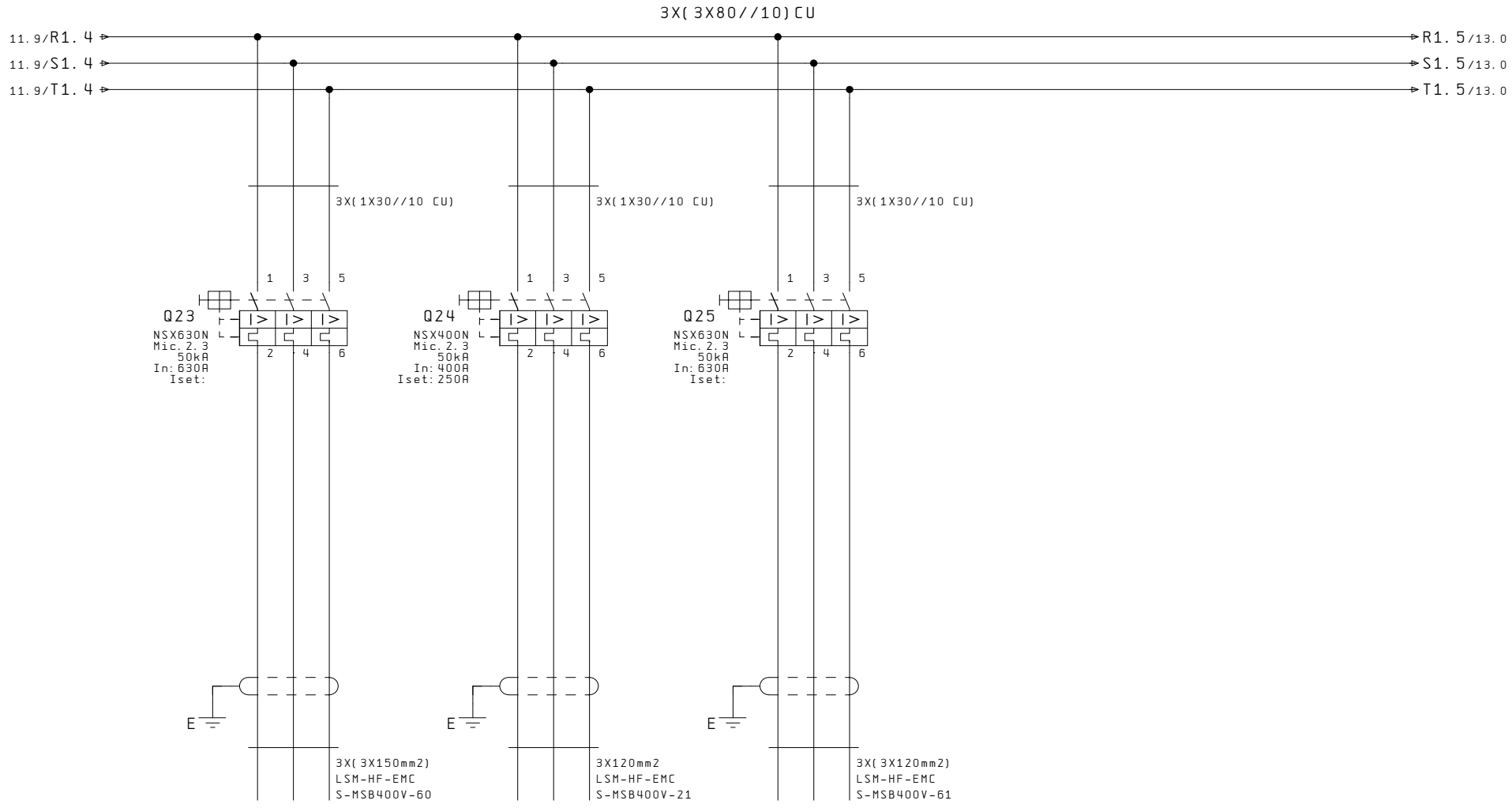

YEDEK

NO. 3 SU JETI
BESLEME
110kW

YEDEK

11.9/R1.4 → R1.5/13.0
11.9/S1.4 → S1.5/13.0
11.9/T1.4 → T1.5/13.0

3X(1X30//10) CU

3X(3X80//10) CU

Q23
NSX630N
Mic. 2.3
50kA
In: 630A
Iset:

Q24
NSX400N
Mic. 2.3
50kA
In: 400A
Iset: 250A

Q25
NSX630N
Mic. 2.3
50kA
In: 630A
Iset:

3X(3X150mm2)
LSM-HF-EMC
S-MSB400V-60

3X120mm2
LSM-HF-EMC
S-MSB400V-21

3X(3X120mm2)
LSM-HF-EMC
S-MSB400V-61



3X(3X80//10) CU

12. 8/R1. 5 → R1. 6/14. 0
12. 8/S1. 5 → S1. 6/14. 0
12. 8/T1. 5 → T1. 6/14. 0

3X(1X30//10) CU

3X(1X30//10) CU

3X(1X20//5) CU

3X(1X20//5) CU

3X(1X20//5) CU

3X(1X20//5) CU

3X(1X20//5) CU

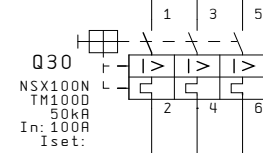
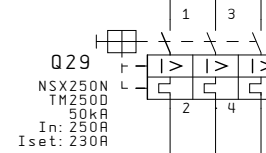
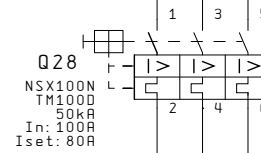
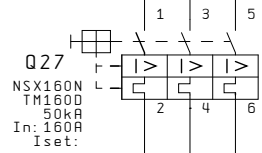
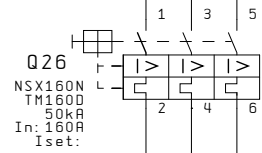

3X50mm2
LSM-HF-EMC
S-MSB400V-62

3X50mm2
LSM-HF-EMC
S-MSB400V-63,

3X35mm2
LSM-HF-EMC
S-MSB400V-64

3X120mm2
LSM-HF-EMC
S-MSB400V-65

3X35mm2
LSM-HF-EMC
S-MSB400V-66

YEDEK

YEDEK

YEDEK

YEDEK

YEDEK



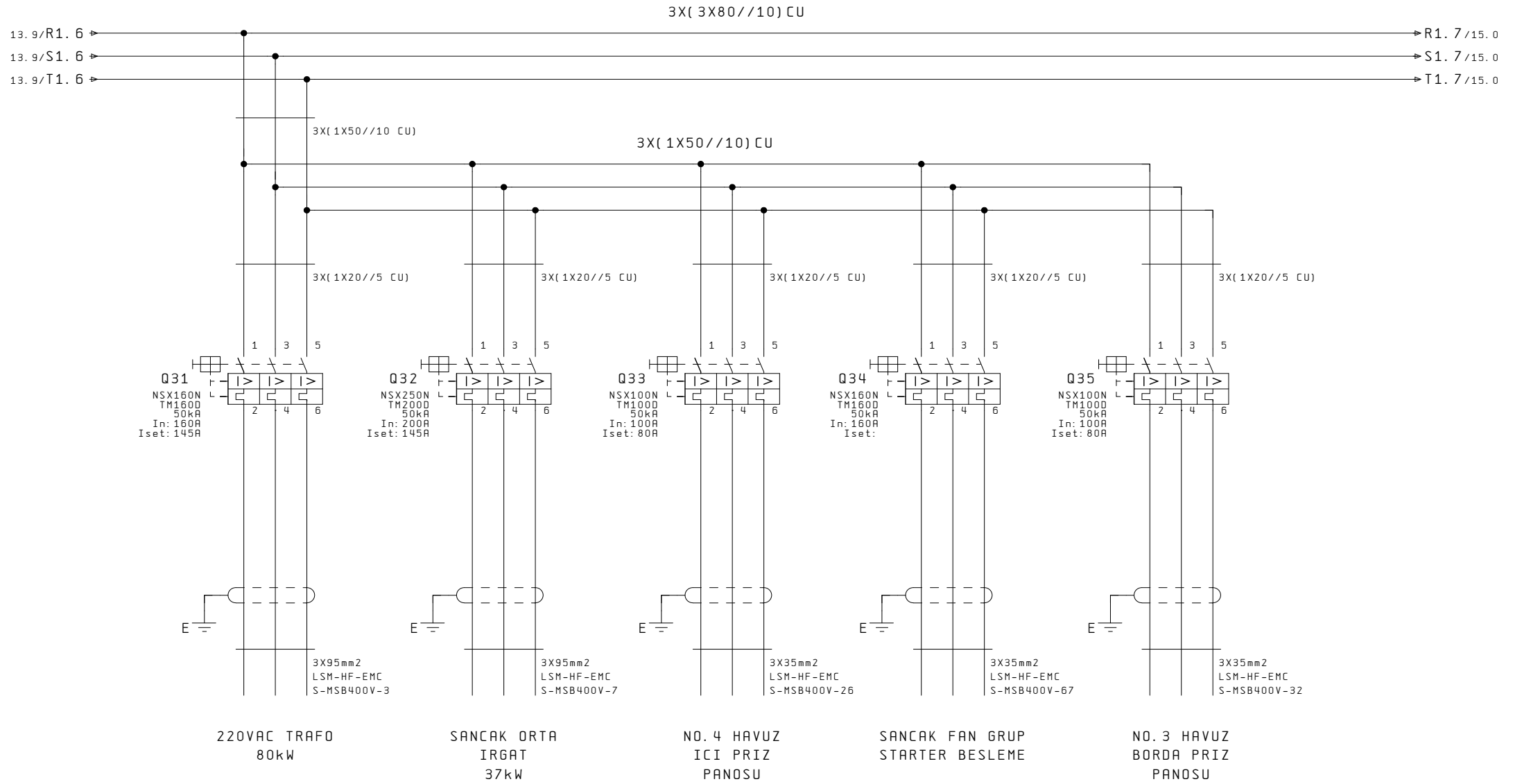

	HILAL GEMİ MUHENDİSLİK	DATE	SANCAK ADP PANO 400VAC TÜKETİM BOLME-4	BEŞİKTAS SHİPYARD	YUZER HAVUZ 3		=
	ELEKTRİK DONANIM VE OTOMASYON SAN. TİC. LTD. STİ Gıptas San. Sitesi B/Blok No:30 İçmeler/TUZLA Tel:0216 395 60 50 GSM:0539 648 88 05 www.hilalgemi.com	DRAWN BY				PROJE KOD	BSK/HLL-YH32
	CHECKED BY				CLASS	RINA	Highest Page Number
							14 63

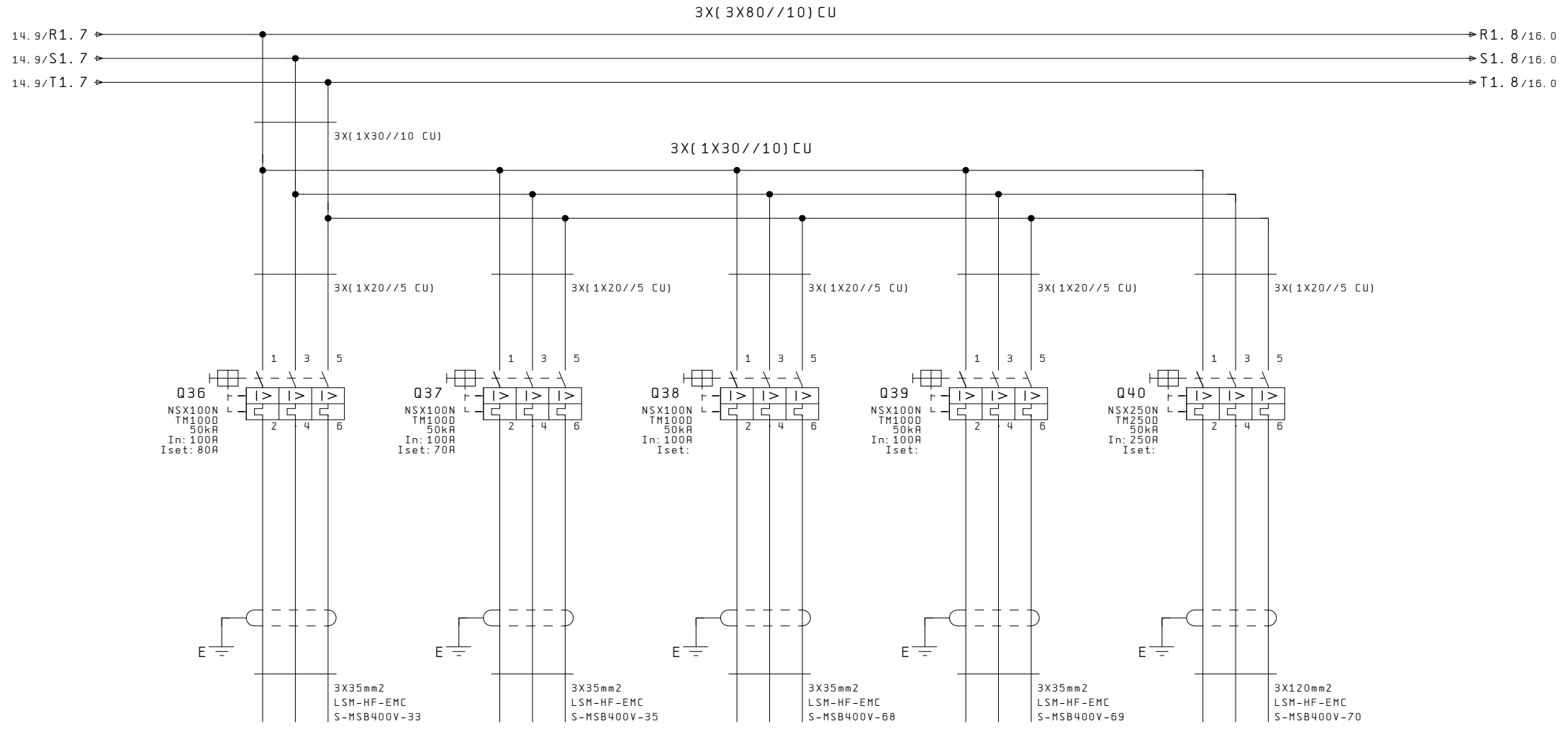

 HILAL GEMİ MUHENDİSLİK ELEKTRİK DONANIM VE OTOMASYON SAN. TİC. LTD. STİ Gıptas San. Sitesi B/Blok No:30 İcmeler/TUZLA Tel:0216 395 60 50 GSM:0539 648 88 05 www.hilalgemi.com	DATE	SANCAK ADP PANO 400VAC TÜKETİM BOLME-4	BESİKTAS SHİPYARD	YUZER HAVUZ 3		=
	DRAWN BY			PROJE KOD	BSK/HLL-YH32	Page Number
CHECKED BY			CLASS	RINA	Highest Page Number	63

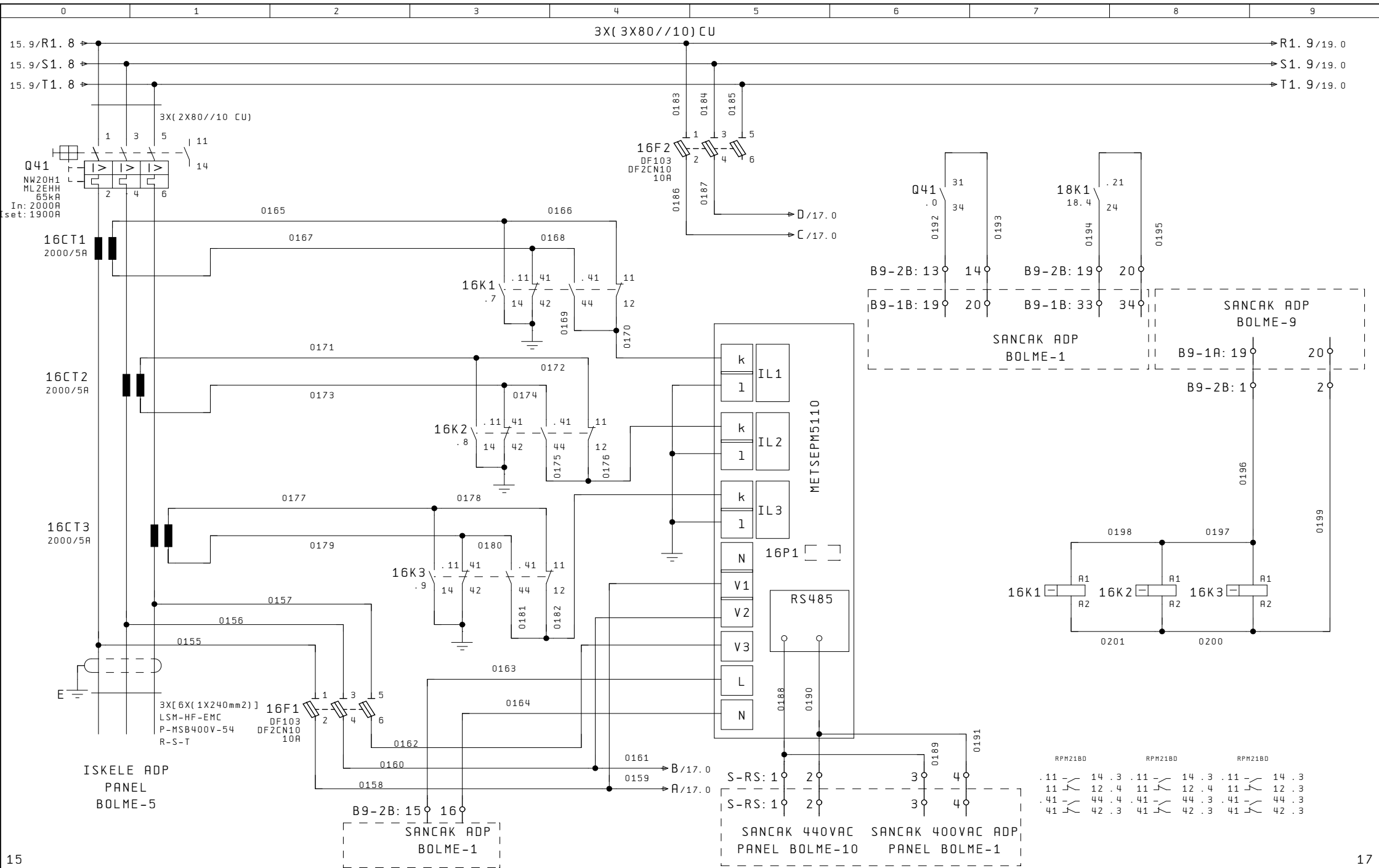

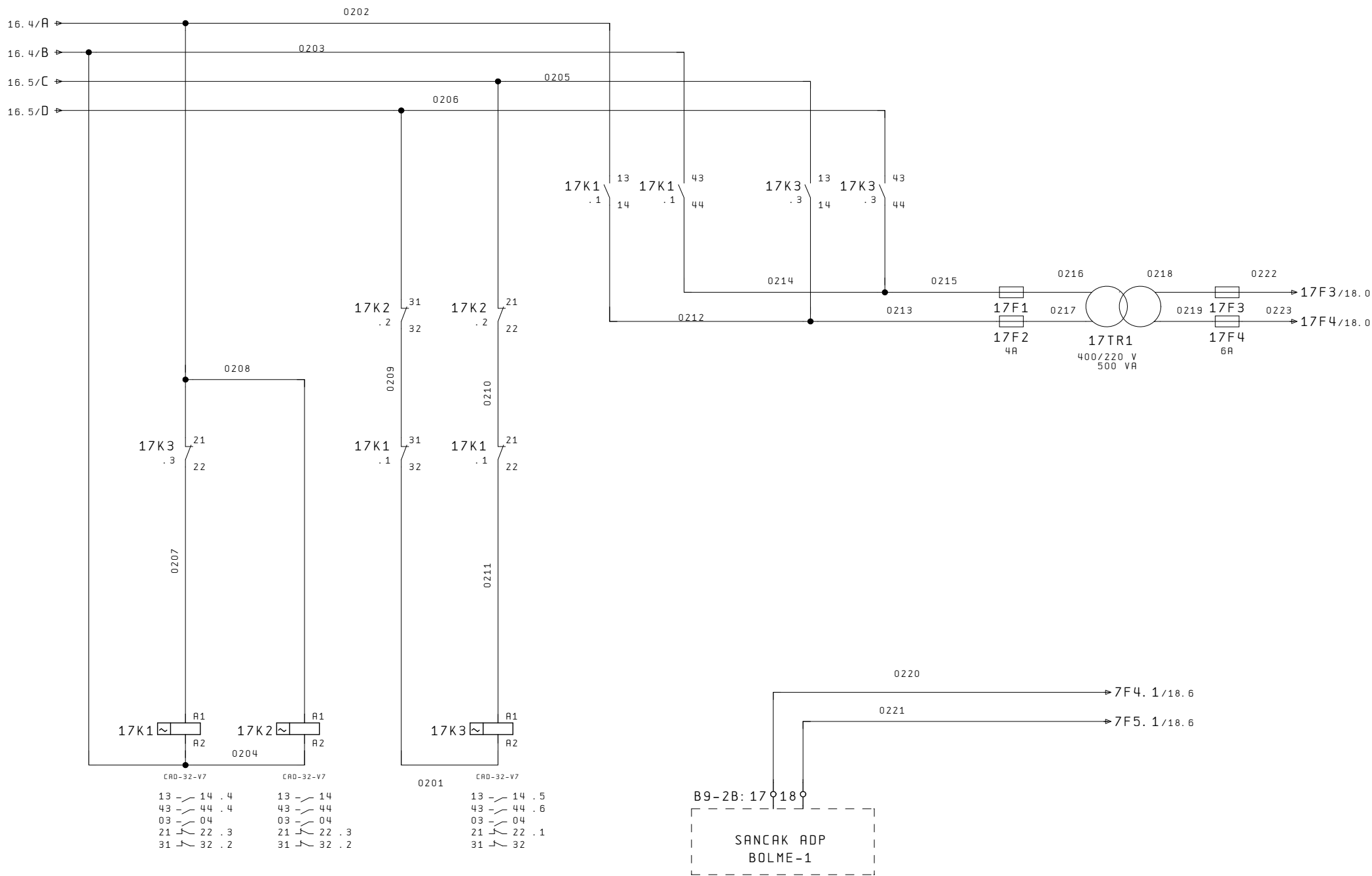

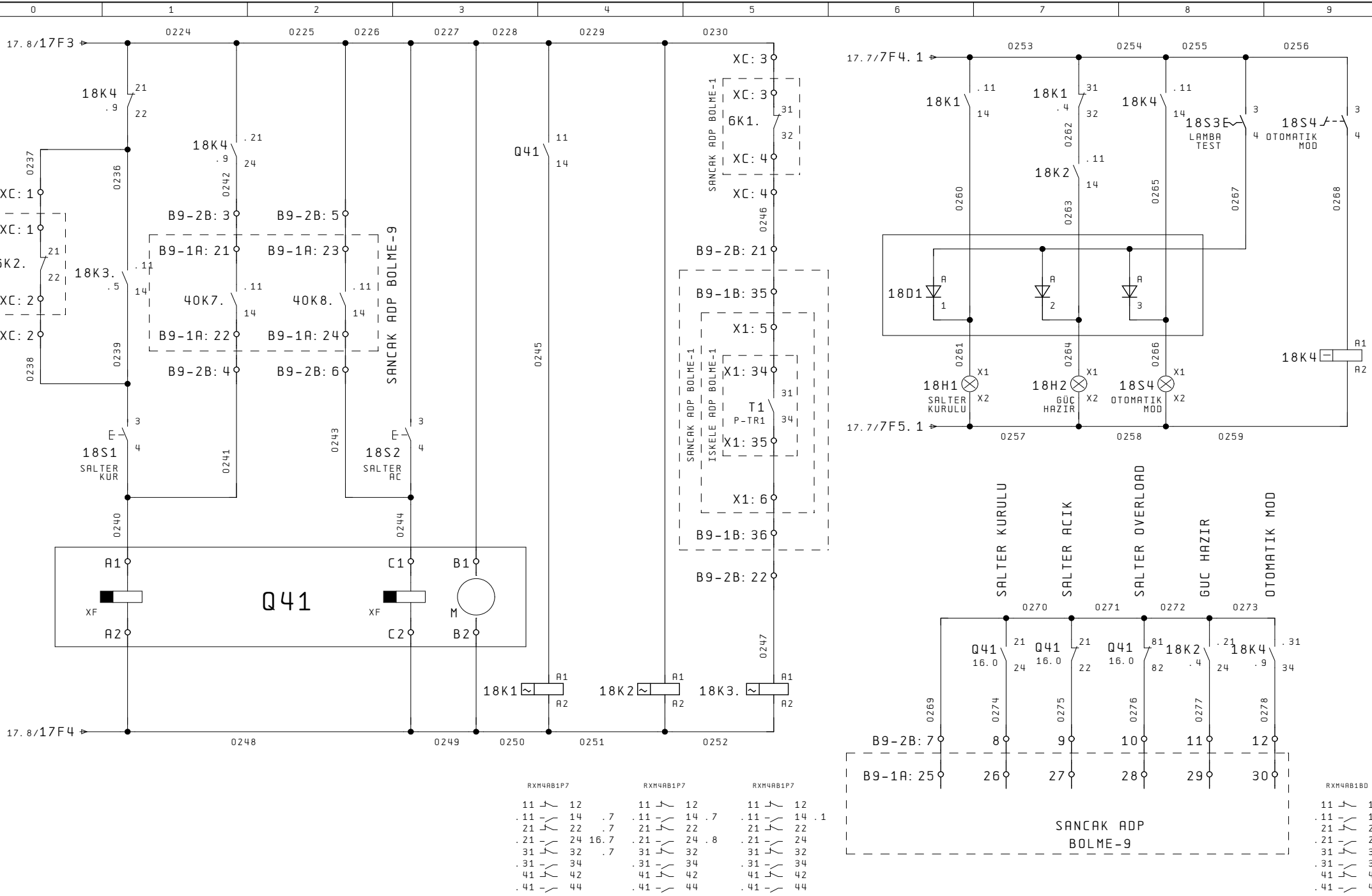

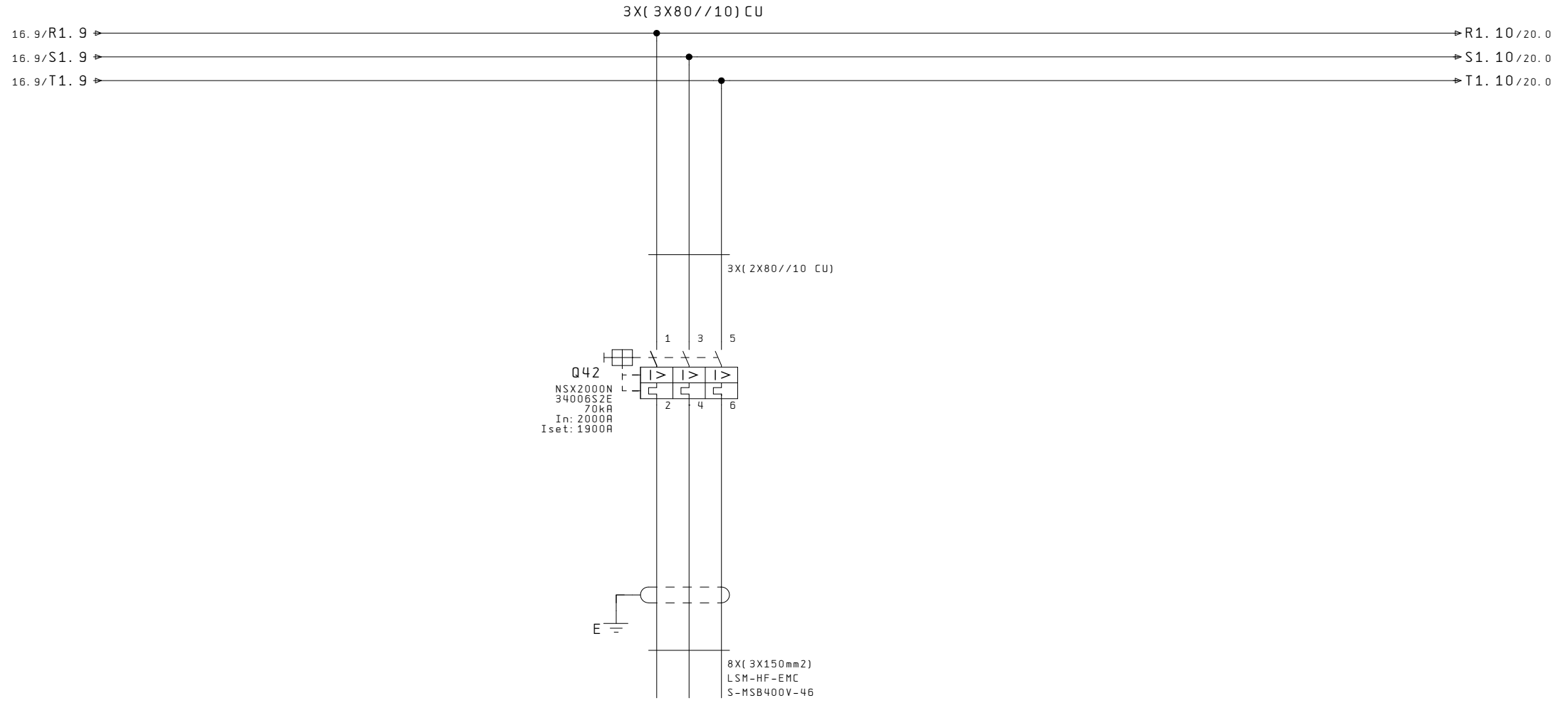

SANCAK KOMPANZASYON
PANOSU
1250kVAR

 HILAL GEMİ MUHENDİSLİK ELEKTRİK DONANIM VE OTOMASYON SAN. TİC. LTD. STİ Gıptas San. Sitesi B/Blok No:30 İcmeler/TUZLA Tel:0216 395 60 50 GSM:0539 648 88 05 www.hilalgemi.com	DATE		SANCAK ADP PANO 400VAC TÜKETİM BOLME-5	BESİKTAS SHİPYARD	YUZER HAVUZ 3		=	
	DRAWN BY				PROJE KOD	BSK/HLL-YH32	Page Number	19
CHECKED BY					CLASS	RINA	Highest Page Number	63

3X(3X80//10) CU

19. 9/R1. 10 → R1. 11/21. 0
 19. 9/S1. 10 → S1. 11/21. 0
 19. 9/T1. 10 → T1. 11/21. 0

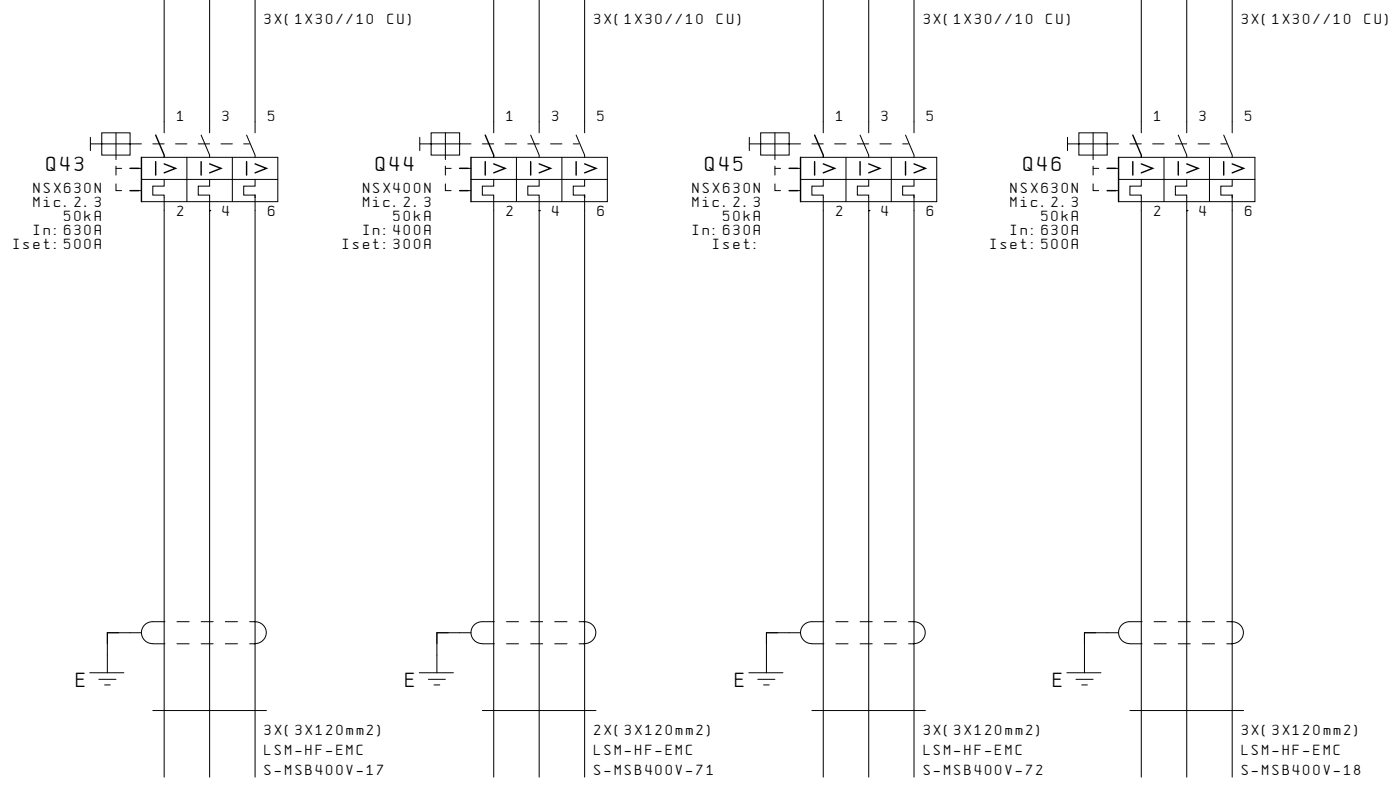

NO. 1 KOMPRESOR
250kW

YANGIN POMPASI-1
160kW

YEDEK

NO. 2 KOMPRESOR
250kW



HILAL GEMİ MUHENDİSLİK
 ELEKTRİK DONANIM VE OTOMASYON SAN. TİC. LTD. STİ
 Gıptas San. Sitesi B/Blok No:30 İcmeler/TUZLA
 Tel:0216 395 60 50 GSM:0539 648 88 05
 www.hilalgemi.com

DATE
 DRAWN BY
 CHECKED BY

SANCAK ADP PANO
 400VAC TUKETİM
 BOLME-6

BESİKTAS SHİPYARD

YUZER HAVUZ 3

PROJE KOD	BSK/HLL-YH32	Page Number	20
CLASS	RINA	Highest Page Number	63

3X(3X80//10) CU

20.9/R1.11 → R1.12/22.0
20.9/S1.11 → S1.12/22.0
20.9/T1.11 → T1.12/22.0

3X(1X40//10) CU

3X(1X40//10) CU

3X(1X20//5) CU

3X(1X20//5) CU

3X(1X20//5) CU

3X(1X20//5) CU

3X(1X20//5) CU

Q47
NSX100N
TM100D
50kA
In: 100A
Iset: 80A

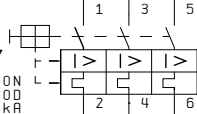

3X35mm2
LSM-HF-EMC
S-MSB400V-23

NO. 1 HAVUZ
ICI PRIZ
PANOSU

Q48
NSX100N
TM100D
50kA
In: 100A
Iset: 80A

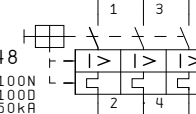

3X35mm2
LSM-HF-EMC
S-MSB400V-24

NO. 2 HAVUZ
ICI PRIZ
PANOSU

Q49
NSX100N
TM100D
50kA
In: 100A
Iset: 80A

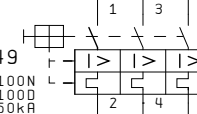

3X35mm2
LSM-HF-EMC
S-MSB400V-25

NO. 3 HAVUZ
ICI PRIZ
PANOSU

Q50
NSX250N
TM250D
50kA
In: 250A
Iset: 230A

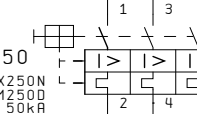

3X150mm2
LSM-HF-EMC
S-MSB400V-5

NO. 2 VINC
BESLEME
122kW

Q51
NSX250N
TM200D
50kA
In: 200A
Iset: 145A

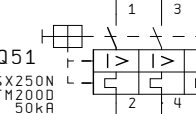

3X95mm2
LSM-HF-EMC
S-MSB400V-8

KIC IRGAT
67kW



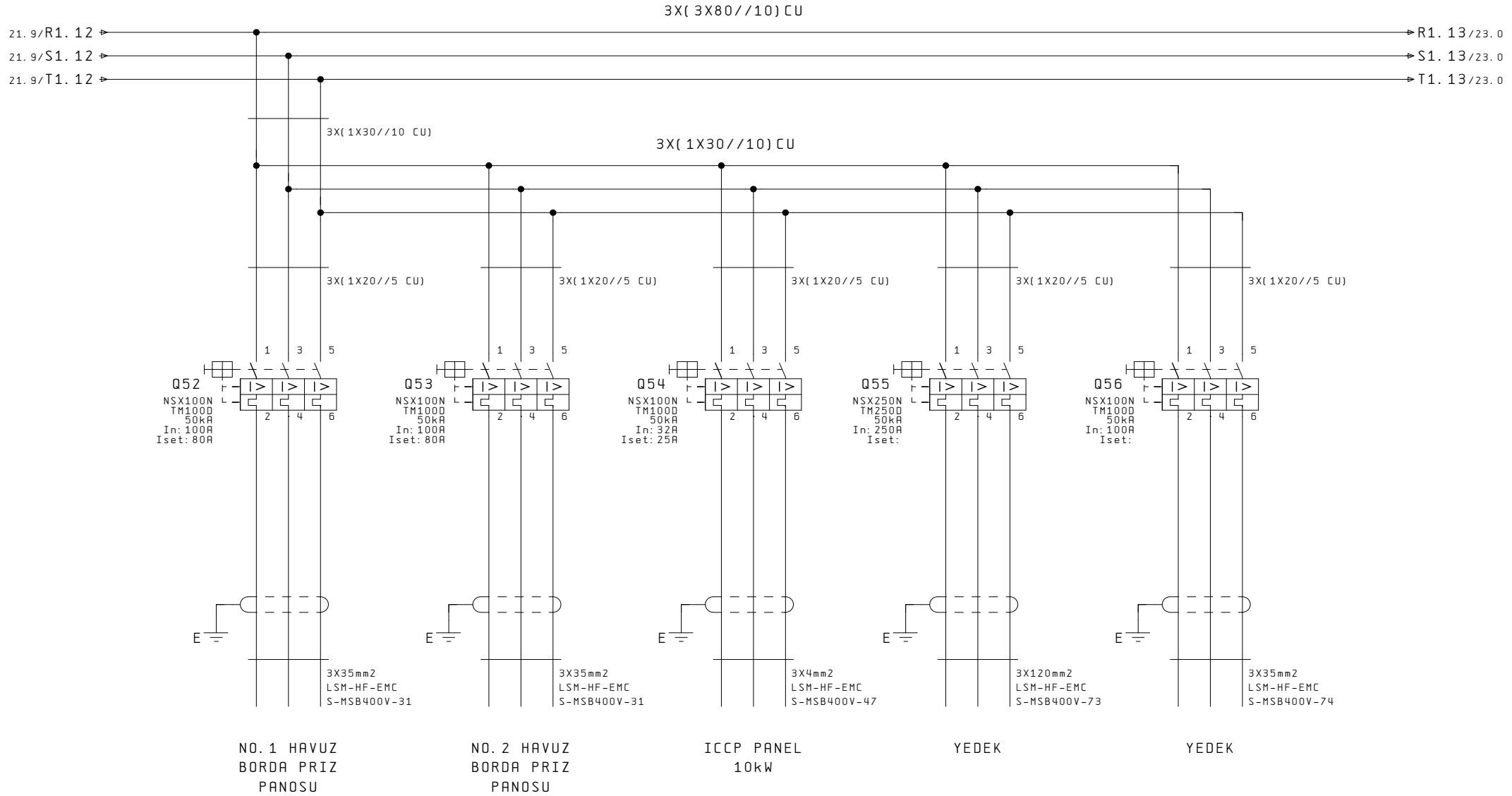

 <p>HILAL GEMİ MUHENDİSLİK ELEKTRİK DONANIM VE OTOMASYON SAN. TİC. LTD. STİ Gıptas San. Sitesi B/Blok No:30 İcmeler/TUZLA Tel:0216 395 60 50 GSM:0539 648 88 05 www.hilalgemi.com</p>	DATE	SANCAK ADP PANO 400VAC TÜKETİM BOLME-6	BEŞİKTAS SHİPYARD	YUZER HAVUZ 3		= + Page Number 22 Highest Page Number 63	
	DRAWN BY			PROJE KOD			BSK/HLL-YH32
	CHECKED BY			CLASS	RINA		

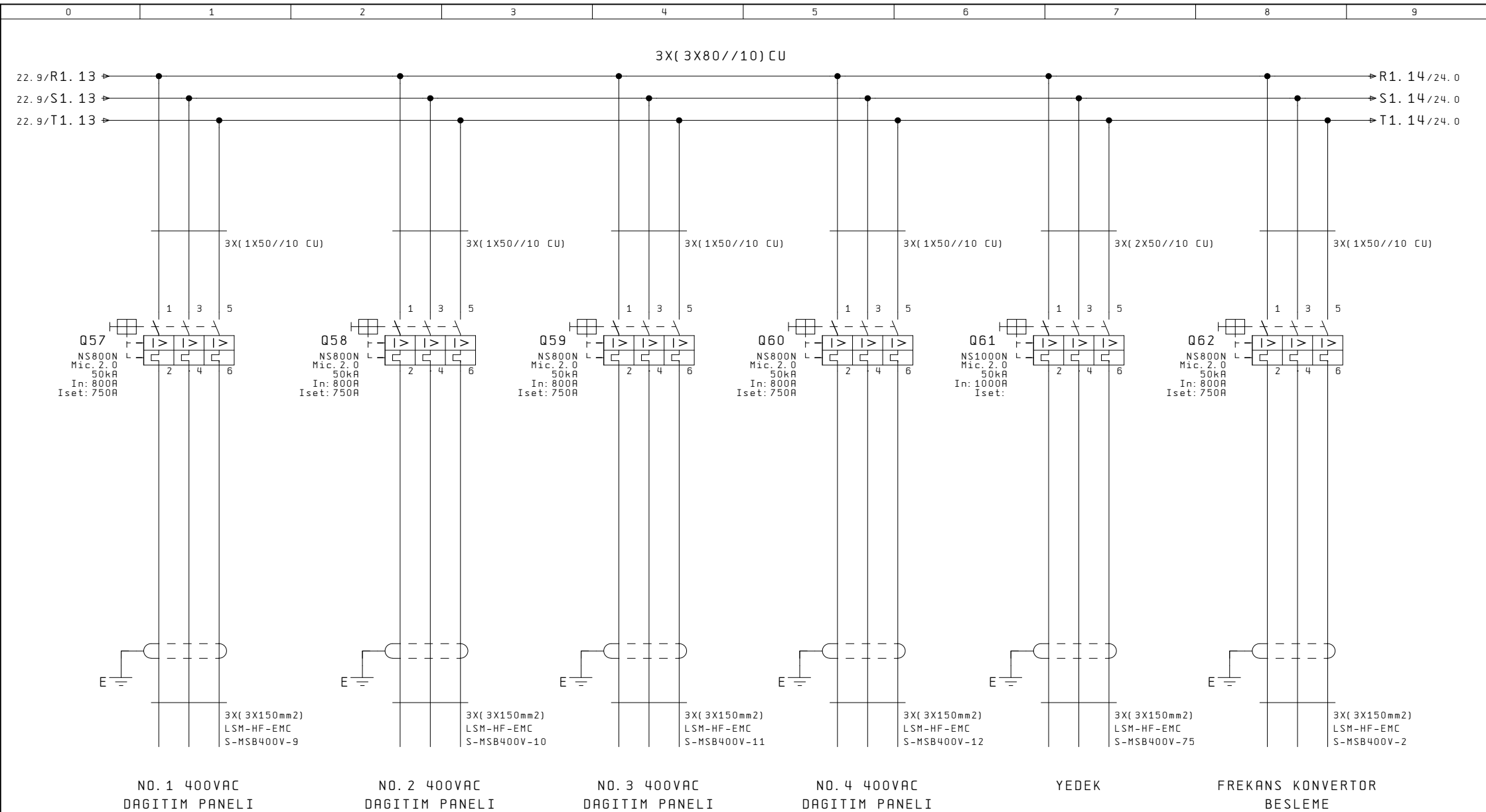

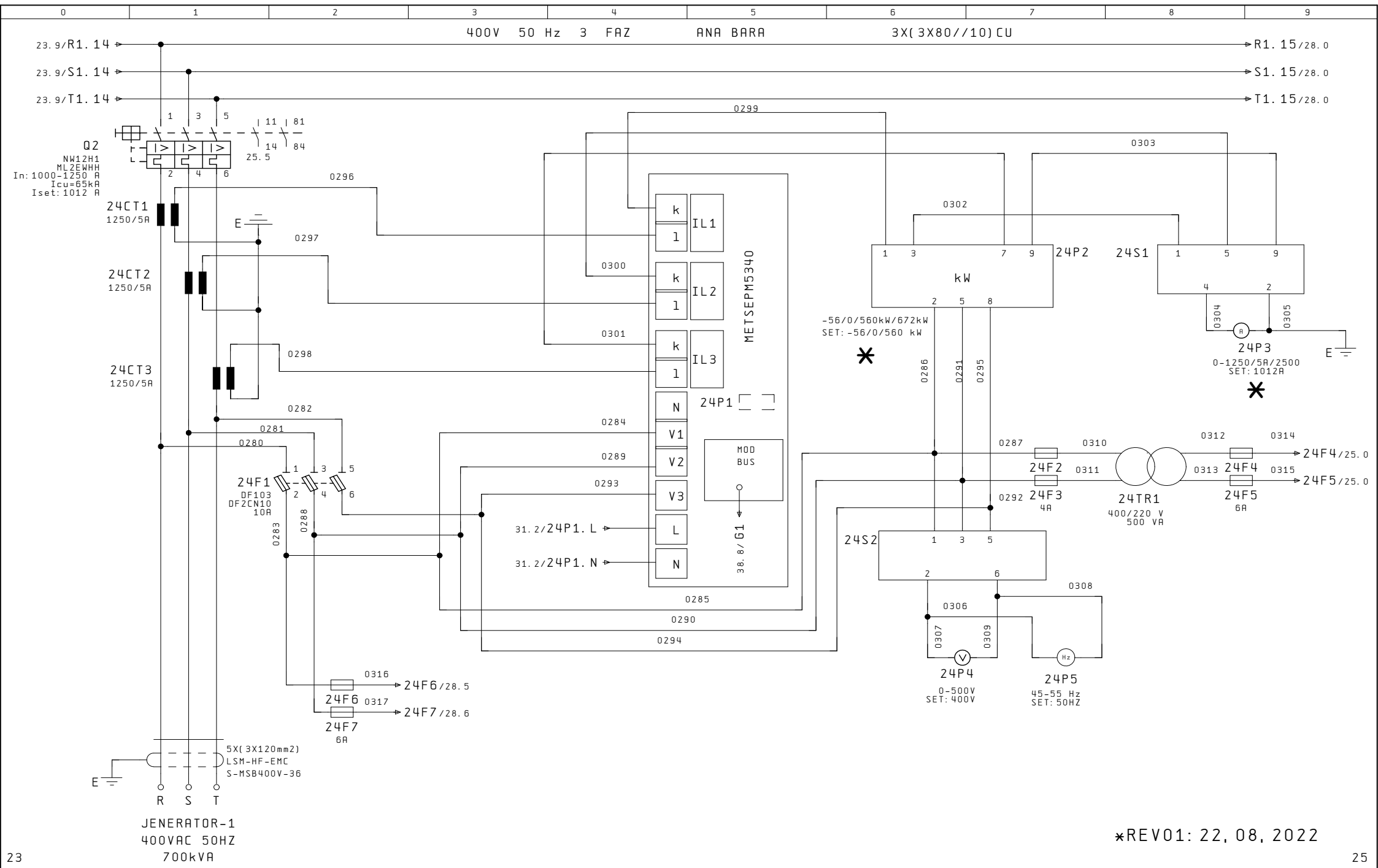

	HILAL GEMİ MUHENDİSLİK ELEKTRİK DONANIM VE OTOMASYON SAN. TİC. LTD. STİ Gıptas San. Sitesi B/Blok No:30 İcmeler/TUZLA Tel:0216 395 60 50 GSM:0539 648 88 05 www.hilalgemi.com		DATE DRAWN BY CHECKED BY	JENERATOR-1 BOLME-8	BESIKTAS SHIPYARD	YUZER HAVUZ 3	= +
	PROJE KOD CLASS	BSK/HLL-YH32 RINA	Page Number Highest Page Number	24 63			

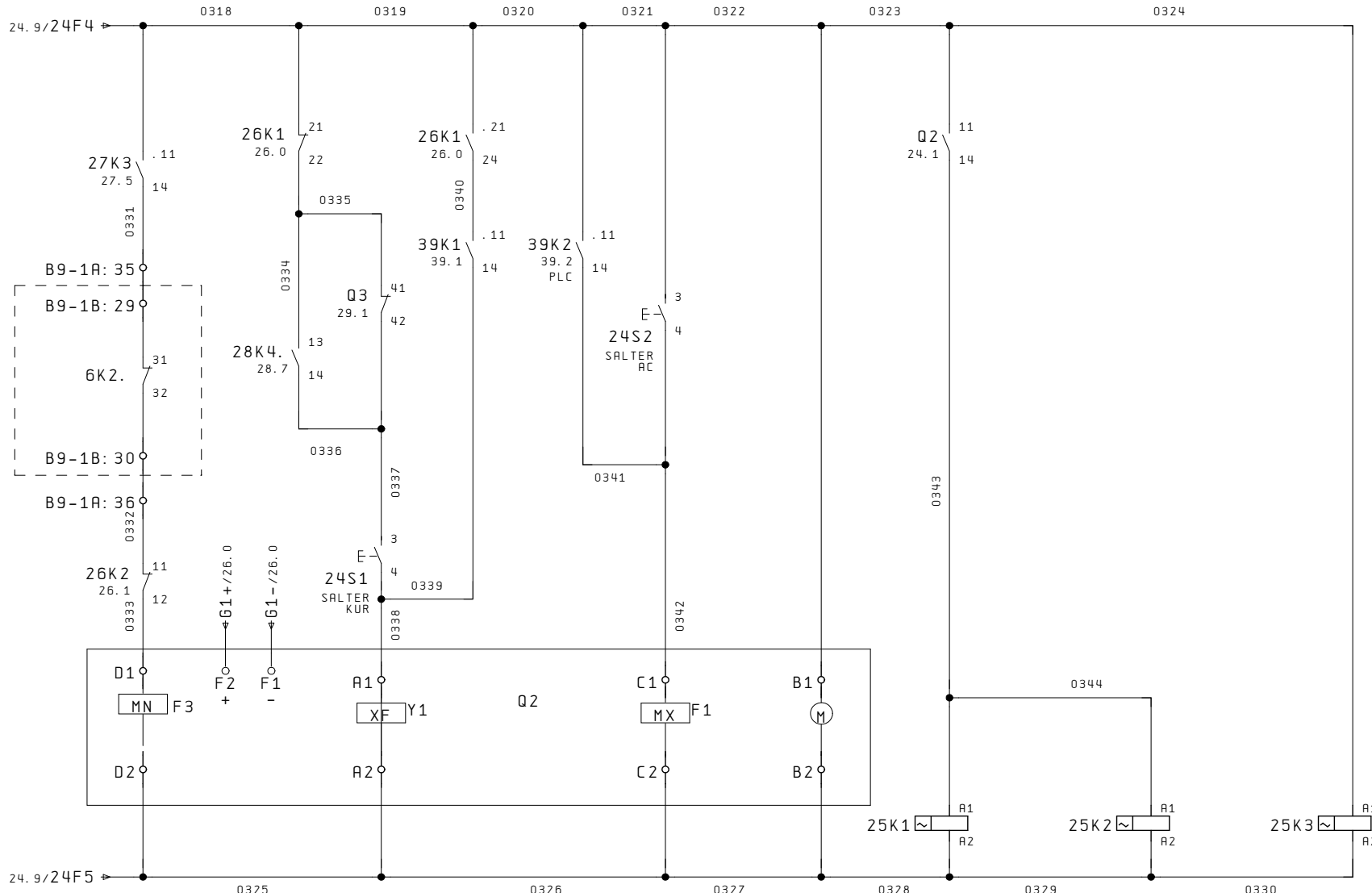

RXM4AB1P7	RXM4AB1P7	RXM4AB1P7
11 - 12	11 - 12	11 - 12
.11 - 14 26.3	.11 - 14 30.8	.11 - 14 26.3
21 - 22 26.3	21 - 22	21 - 22
.21 - 24	.21 - 24	.21 - 24
31 - 32 30.8	31 - 32	31 - 32
.31 - 34	.31 - 34	.31 - 34 33.3
41 - 42 30.9	41 - 42	41 - 42
.41 - 44	.41 - 44	.41 - 44

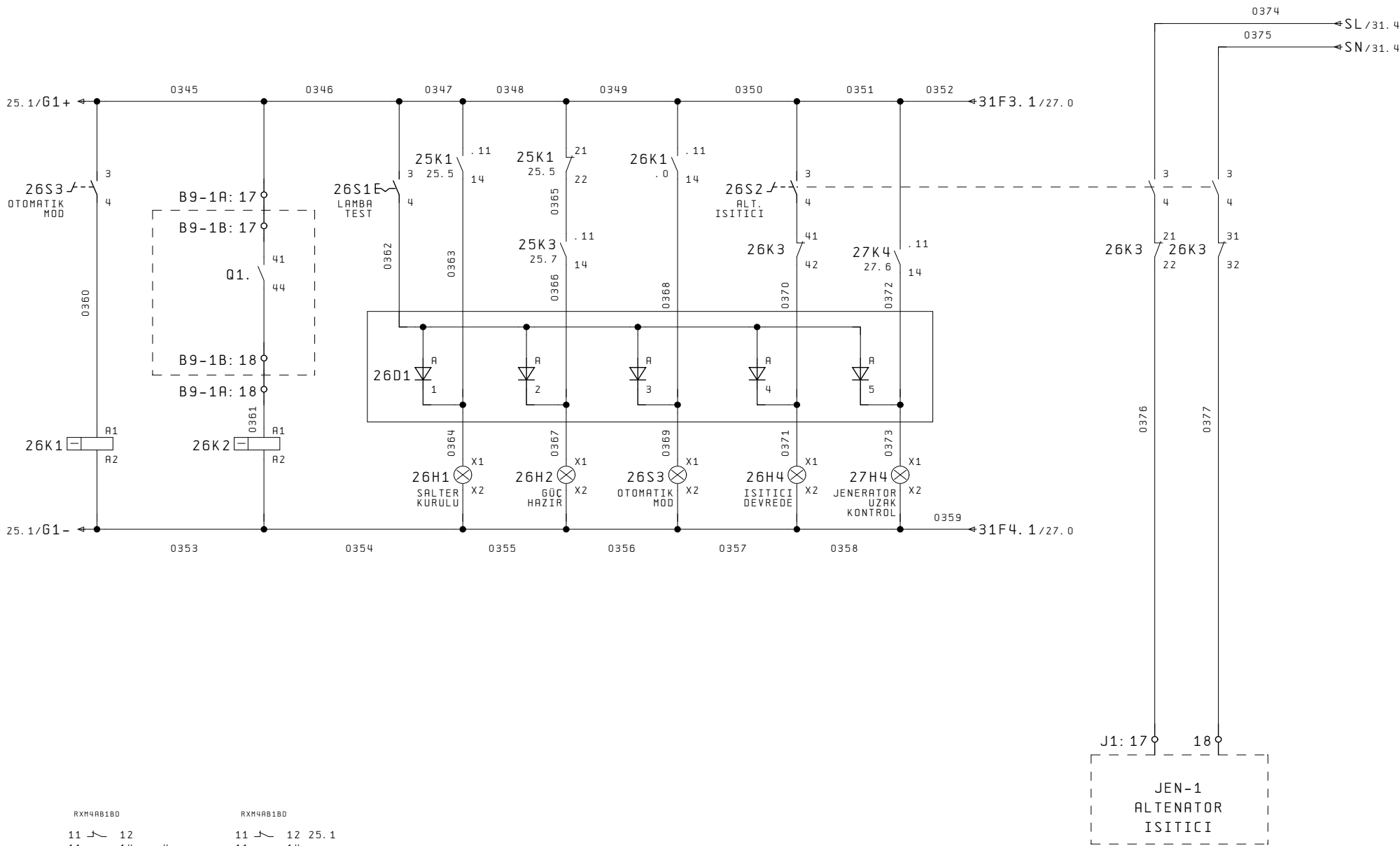

RXH4AB1B0	RXH4AB1B0
11 - 12	11 - 12 25.1
.11 - 14 .4	.11 - 14
21 - 22 25.1	21 - 22 30.1
.21 - 24 25.2	.21 - 24
31 - 32 27.0	31 - 32
.31 - 34	.31 - 34
41 - 42	41 - 42
.41 - 44 33.3	.41 - 44

J1: 17 18

JEN-1
ALTENATOR
ISITICI

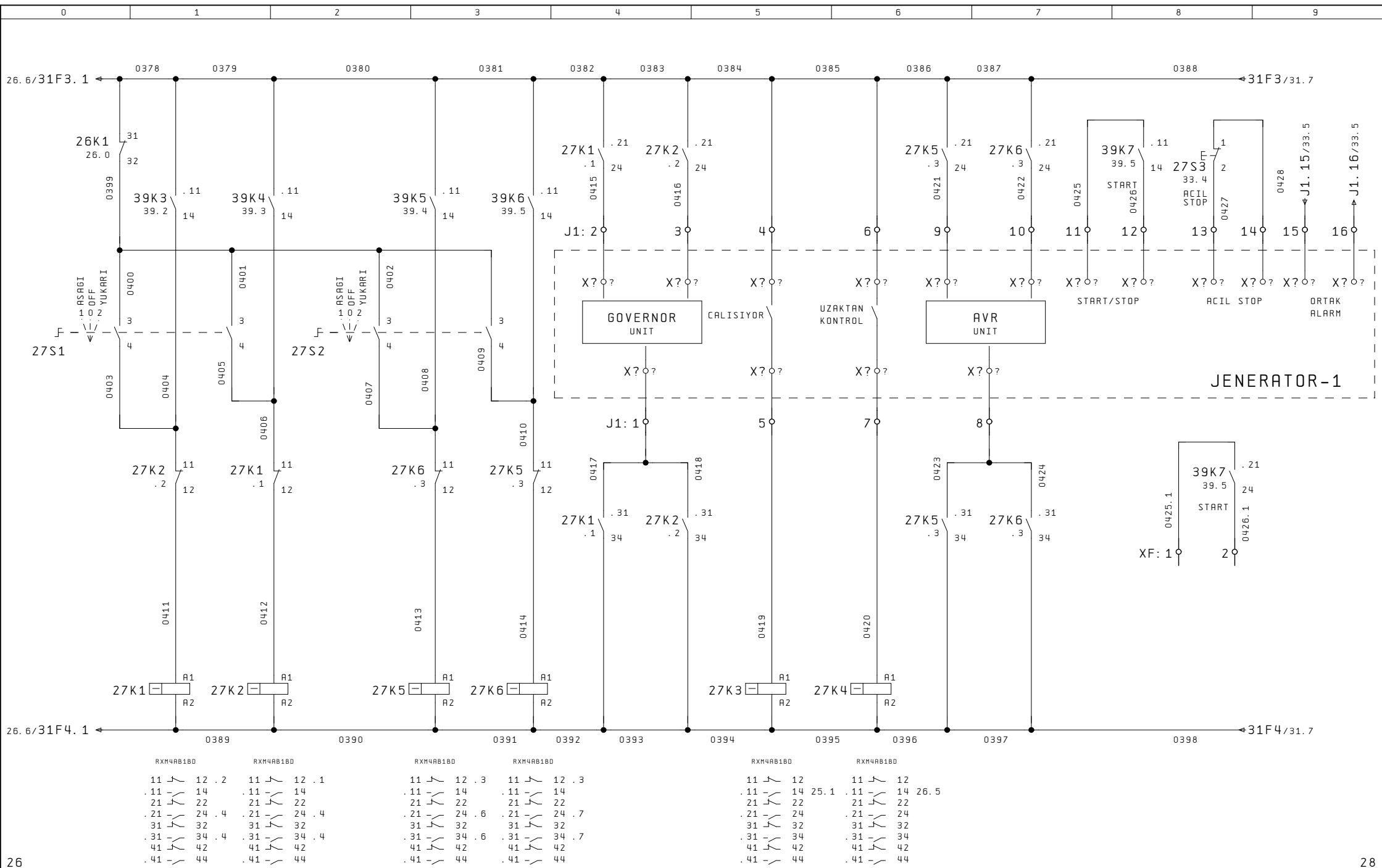

24. 9/R1. 15 → R1. 16/29. 0
 24. 9/S1. 15 → S1. 16/29. 0
 24. 9/T1. 15 → T1. 16/29. 0

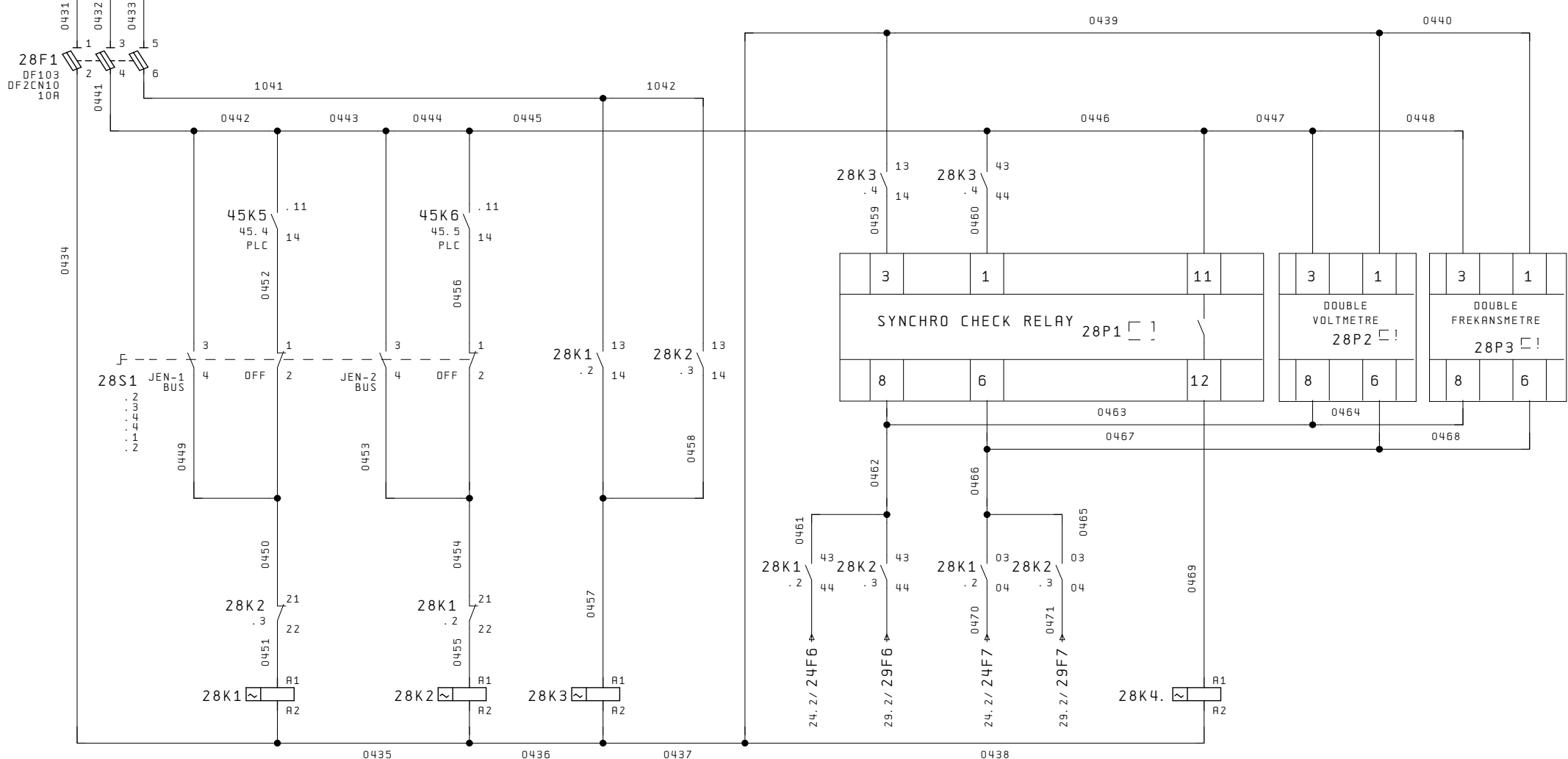

CAD-32-V7
 13 - 14 . 4
 21 - 22 . 3
 43 - 44 . 5
 03 - 04 . 6
 31 - 32
 53 - 54 33. 4

CAD-32-V7
 13 - 14 . 4
 21 - 22 . 2
 43 - 44 . 5
 03 - 04 . 6
 31 - 32
 53 - 54 33. 7

CAD-32-V7
 13 - 14 . 5
 43 - 44 . 6
 03 - 04
 21 - 22
 31 - 32

CAD-32-V7
 13 - 14 25. 1
 43 - 44 33. 4
 03 - 04
 21 - 22
 31 - 32
 53 - 54 33. 7

400V 50 Hz 3 FAZ ANA BARA

3X(3X80//10) CU

28. 8/R1. 16
28. 8/S1. 16
28. 8/T1. 16

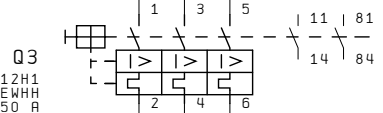

Q3
NW12H1
MLZEWHH
In: 1000-1250 A
Icu=65kA
Iset: 1012 A

29CT1
1250/5A
29CT2
1250/5A
29CT3
1250/5A

29F1
DF103
DF2CN10
10A

5X(3X120mm²)
LSM-HF-EMC
S-MSB400V-37

JENERATOR-2
400VAC 50HZ
700kVA

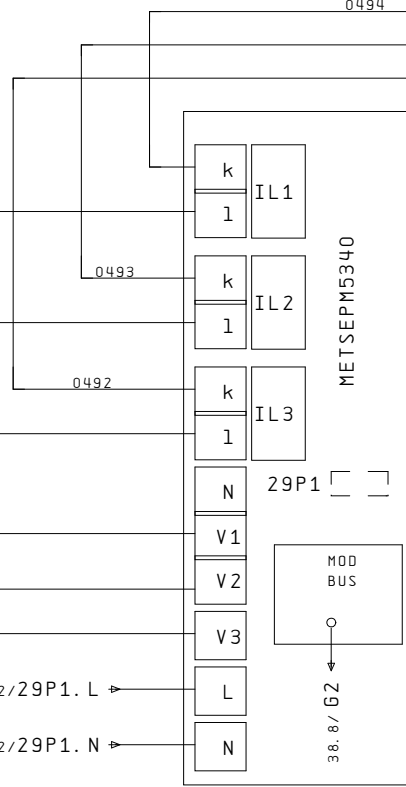

-56/0/560kW/672kW
SET: -56/0/560 kW

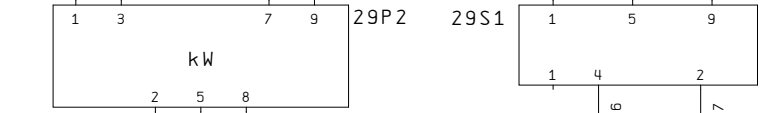

0-1250/5A/2500
SET: 1012A

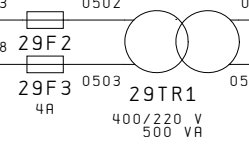

400/220 V
500 VA

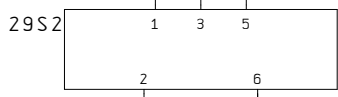

29P4
0-500V
SET: 400V

29P5
45-55 Hz
SET: 50Hz

*REV01: 22. 08. 2022



HILAL GEMİ MUHENDİSLİK
ELEKTRİK DONANIM VE OTOMASYON SAN. TİC. LTD. STİ
Gıptas San. Sitesi B/Blok No:30 İcmeler/TUZLA
Tel:0216 395 60 50 GSM:0539 648 88 05
www.hilalgemi.com

DATE
DRAWN BY
CHECKED BY

JENERATOR-2
BOLME-9

BESIKTAS SHIPYARD

YUZER HAVUZ 3
PROJE KOD
CLASS

BSK/HLL-YH32
RINA
Page Number
Highest Page Number

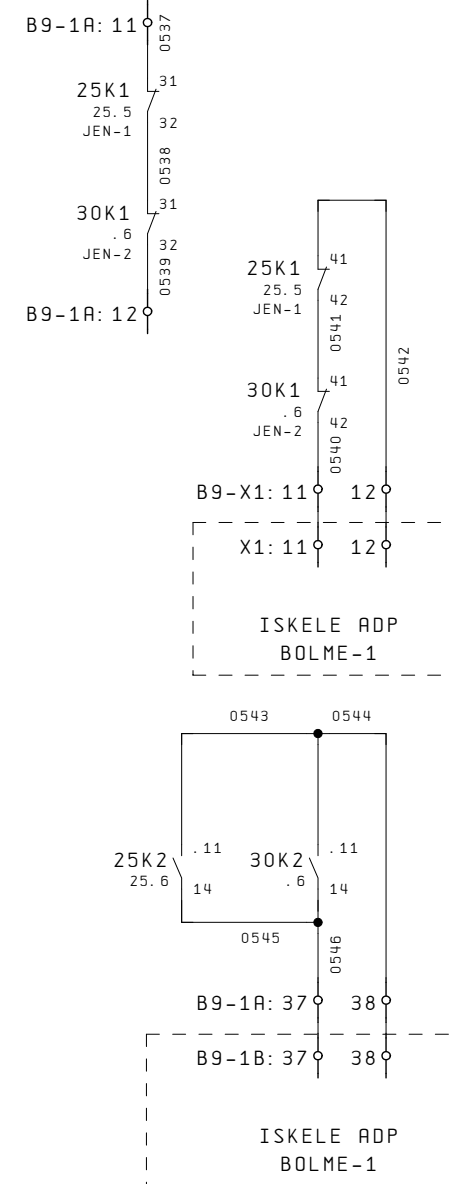
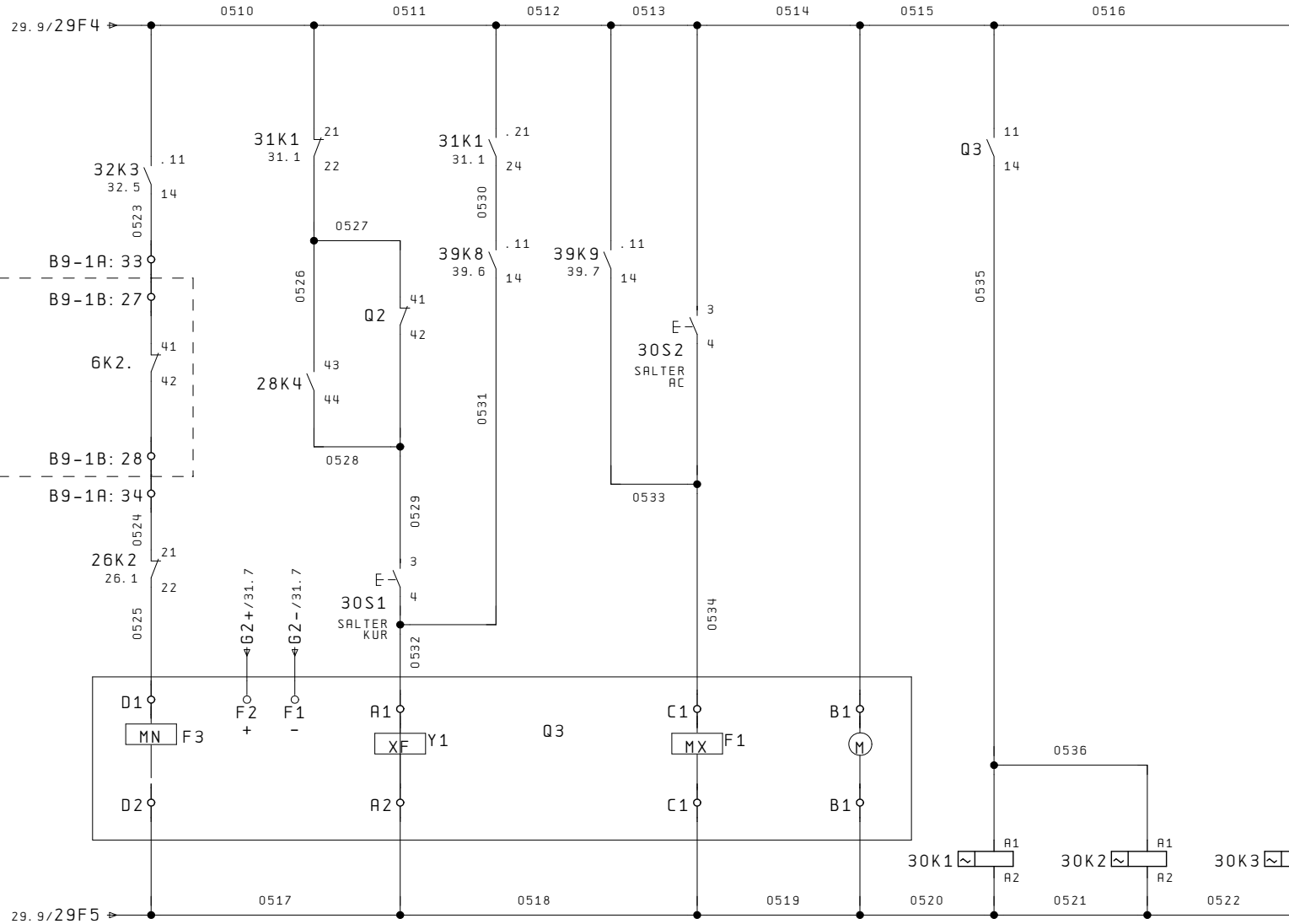

RXM4AB1P7		RXM4AB1P7		RXM4AB1P7	
11	12	11	12	11	12
.11	14	.11	14	.11	14
21	22	21	22	21	22
.21	24	.21	24	.21	24
31	32	31	32	31	32
.31	34	.31	34	.31	34
41	42	41	42	41	42
.41	44	.41	44	.41	44



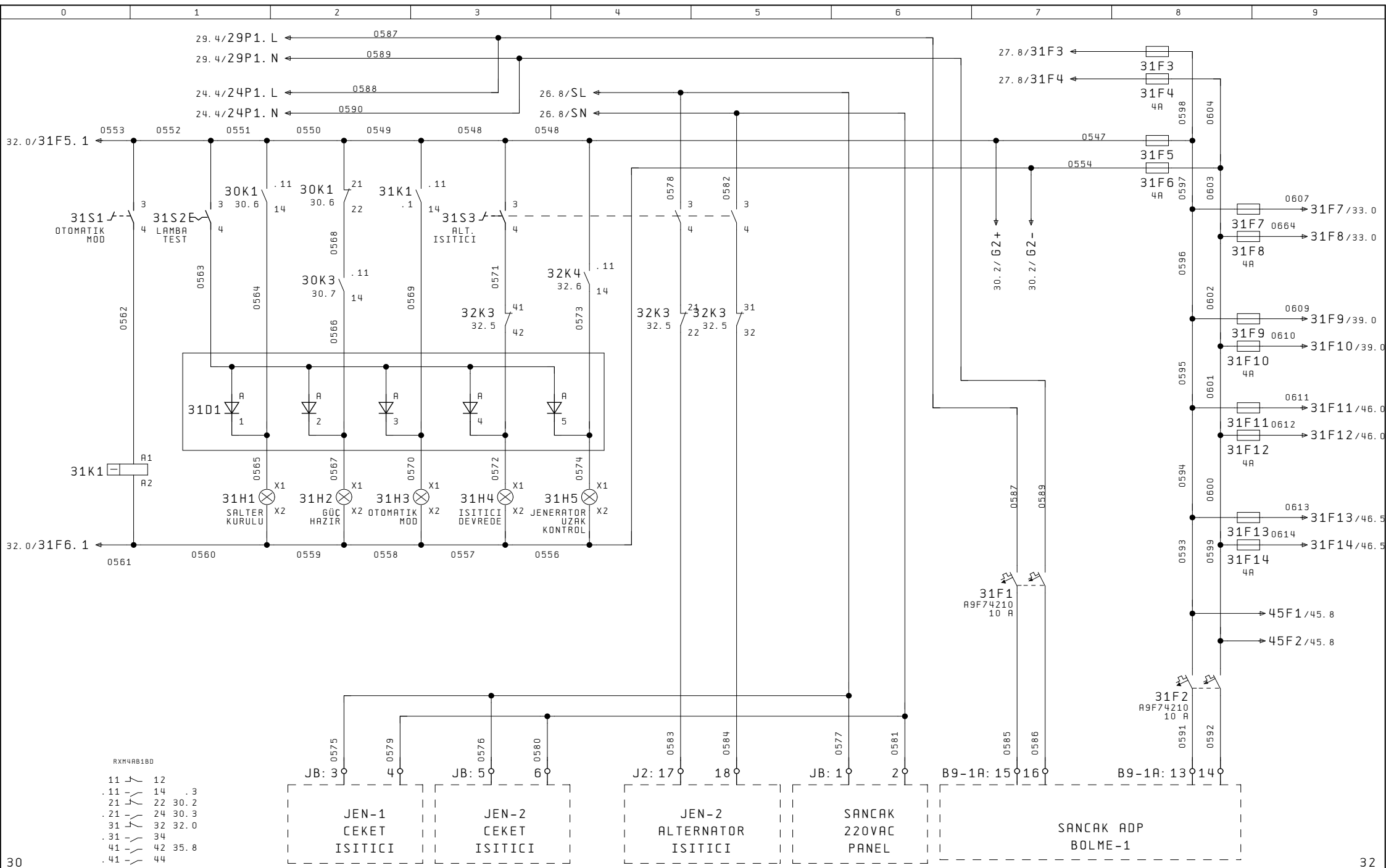

RXM4AB180

11	12
.11	14 .3
21	22 30.2
.21	24 30.3
31	32 32.0
.31	34
41	42 35.8
.41	44

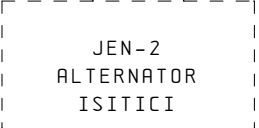
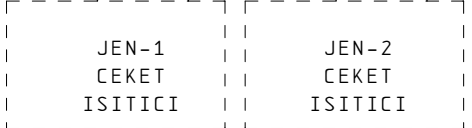

30

32

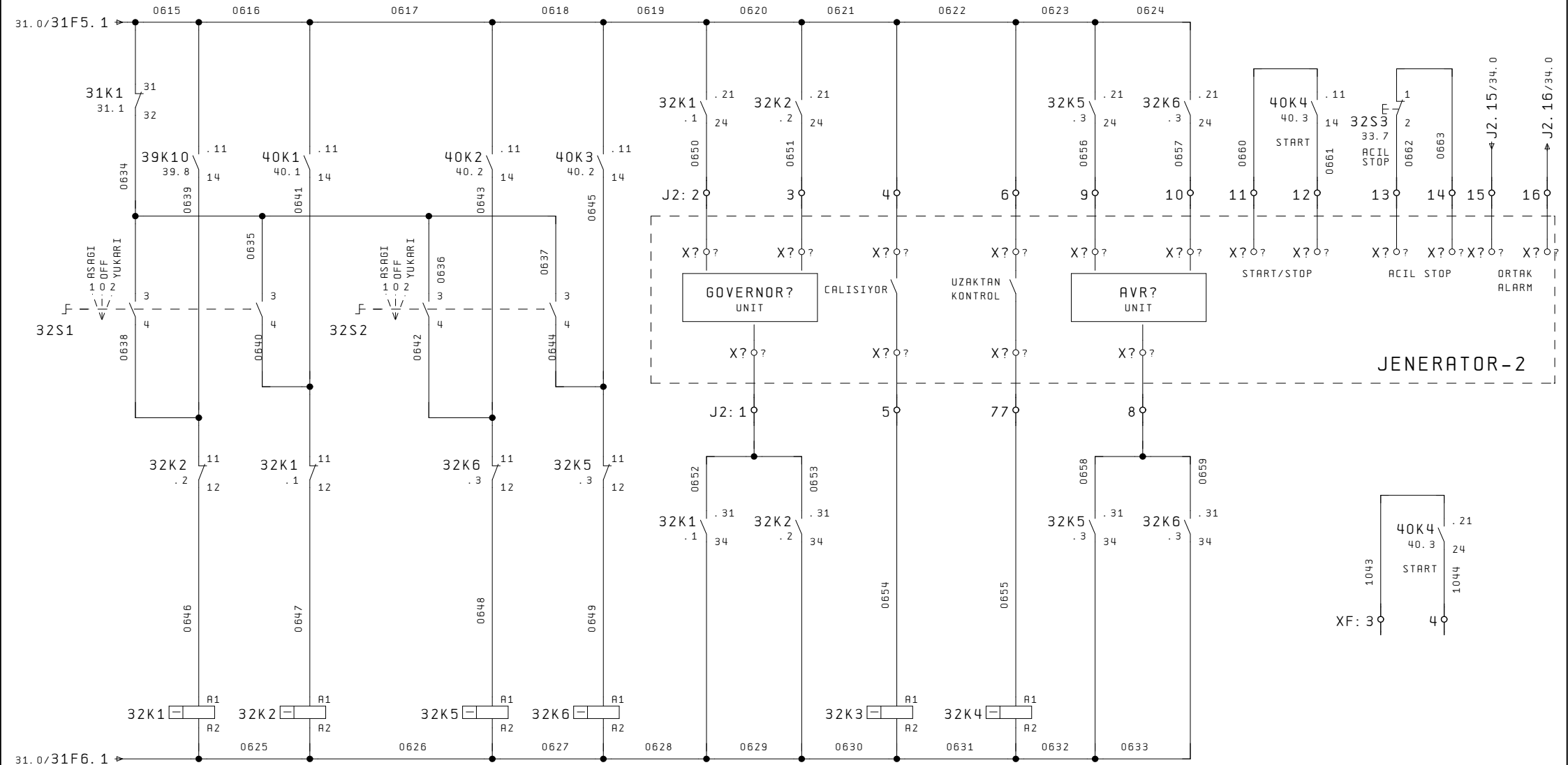

31.0/31F6.1

RXM4AB180	RXM4AB180	RXM4AB180	RXM4AB180	RXM4AB180	RXM4AB180
11 / 12 . 2	11 / 12 . 1	11 / 12 . 3	11 / 12 . 3	11 / 12	11 / 12
. 11 / 14	. 11 / 14	. 11 / 14	. 11 / 14	. 11 / 14 30.1	. 11 / 14 31.4
21 / 22	21 / 22	21 / 22	21 / 22	21 / 22 31.4	21 / 22
. 21 / 24 . 4	. 21 / 24 . 5	. 21 / 24 . 6	. 21 / 24 . 7	. 21 / 24	. 21 / 24
31 / 32	31 / 32	31 / 32	31 / 32	31 / 32 31.5	31 / 32
. 31 / 34 . 4	. 31 / 34 . 5	. 31 / 34 . 6	. 31 / 34 . 7	. 31 / 34	. 31 / 34
41 / 42	41 / 42	41 / 42	41 / 42	41 / 42 31.3	41 / 42
. 41 / 44	. 41 / 44	. 41 / 44	. 41 / 44	. 41 / 44	. 41 / 44

34A1

TM3DI32K

SCHNEIDER

GEN-2 ORTAK ALARM	01 S-TR1 SALTER KURULU	01 S-TR1 SALTER ACIK	01 S-TR1 SALTER OVERLOAD	01 S-TR1 GUC HAZIR	01 S-TR1 OTO MOD	041 P-TRNS SALTER KURULU	041 P-TRNS SALTER ACIK	041 P-TRNS SALTER OVERLOAD	041 P-TRNS GUC HAZIR	041 P-TRNS OTO MOD	T1 P-TR1 SALTER KURULU	T1 P-TR1 SALTER ACIK	T1 P-TR1 SALTER OVERLOAD	T1 P-TR1 GUC HAZIR	T1 P-TR1 OTO MOD
----------------------	---------------------------	-------------------------	-----------------------------	-----------------------	---------------------	-----------------------------	---------------------------	-------------------------------	-------------------------	-----------------------	---------------------------	-------------------------	-----------------------------	-----------------------	---------------------

CN1	I0-20	I1-18	I2-16	I3-14	I4-12	I5-10	I6-8	I7-6	COMO-4	I8-19	I9-17	I10-15	I11-13	I12-11	I13-9	I14-7	I15-5	COMO-3
-----	-------	-------	-------	-------	-------	-------	------	------	--------	-------	-------	--------	--------	--------	-------	-------	-------	--------

KL1: 1	3	5	7	9	11	13	15	17	2	4	6	8	10	12	14	16	18
--------	---	---	---	---	----	----	----	----	---	---	---	---	----	----	----	----	----

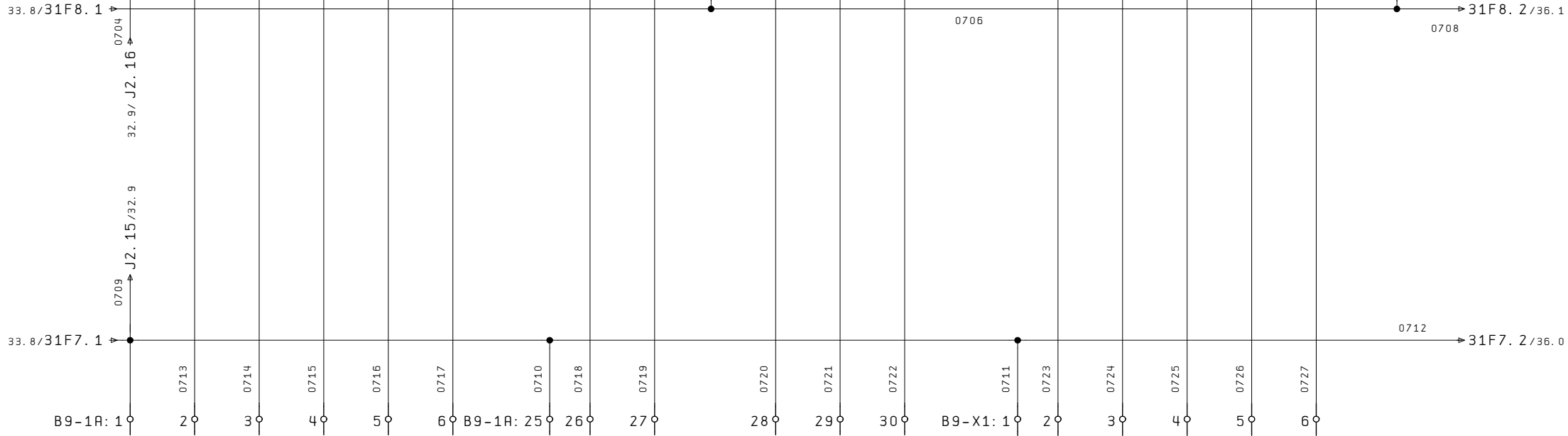
ISKELE ADP
BOLME-1

35

33



HILAL GEMI MUHENDISLIK
ELEKTRIK DONANIM VE OTOMASYON SAN. TIC. LTD. STI
Giptas San. Sitesi B/Blok No:30 Icmeler/TUZLA
Tel:0216 395 60 50 GSM:0539 648 88 05
www.hilalgemi.com

DATE
DRAWN BY
CHECKED BY

OTOMATIK KONTROL
BOLME-9

BESIKTAS SHIPYARD

YUZER HAVUZ 3

PROJE KOD
CLASS

BSK/HLL-YH32
RINA

Page Number 34
Highest Page Number 63

34A1

TM3DI32K

SCHNEIDER

T38 P-TRNS
SALTER
KURULUT38 P-TRNS
SALTER
ACIKT38 P-TRNS
SALTER
OVERLOADT38 P-TRNS
GUC
HAZIRT38 P-TRNS
OTO
MODQ63 SANCRAK ADP
SALTER
KURULUQ63 SANCRAK ADP
SALTER
ACIKQ63 SANCRAK ADP
SALTER
OVERLOADQ63 SANCRAK ADP
GUC
HAZIRQ63 SANCRAK ADP
OTO
MODQ64 SANCRAK ADP
SALTER
KURULUQ64 SANCRAK ADP
SALTER
ACIKQ64 SANCRAK ADP
SALTER
OVERLOADQ64 SANCRAK ADP
GUC
HAZIRQ64 SANCRAK ADP
OTO
MODGEN2
OTO
MODE

CN2

I0-20

I1-18

I2-16

I3-14

I4-12

I5-10

I6-8

I7-6

COMO-4

I8-19

I9-17

I10-15

I11-13

I12-11

I13-9

I14-7

I15-5

COMO-3

KL2: 1 3 5 7 9 11 13 15 17 2 4 6 8 10 12 14 16 18

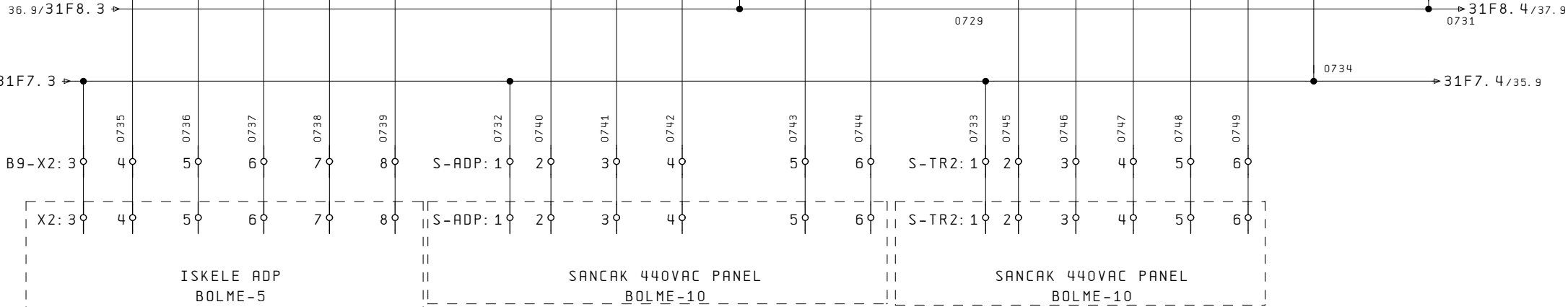

34

36



HILAL GEMİ MUHENDİSLİK
ELEKTRİK DONANIM VE OTOMASYON SAN. TİC. LTD. STİ
Gıptas San. Sitesi B/Blok No:30 İçmeler/TUZLA
Tel:0216 395 60 50 GSM:0539 648 88 05
www.hilalgemi.com

DATE
DRAWN BY
CHECKED BY

OTOMATİK KONTROL
BOLME-9

BESİKTAS SHİPYARD

YUZER HAVUZ 3

PROJE KOD
CLASS

BSK/HLL-YH32
RINA

Page Number 35
Highest Page Number 36

35A1

TM3DI32K

SCHNEIDER

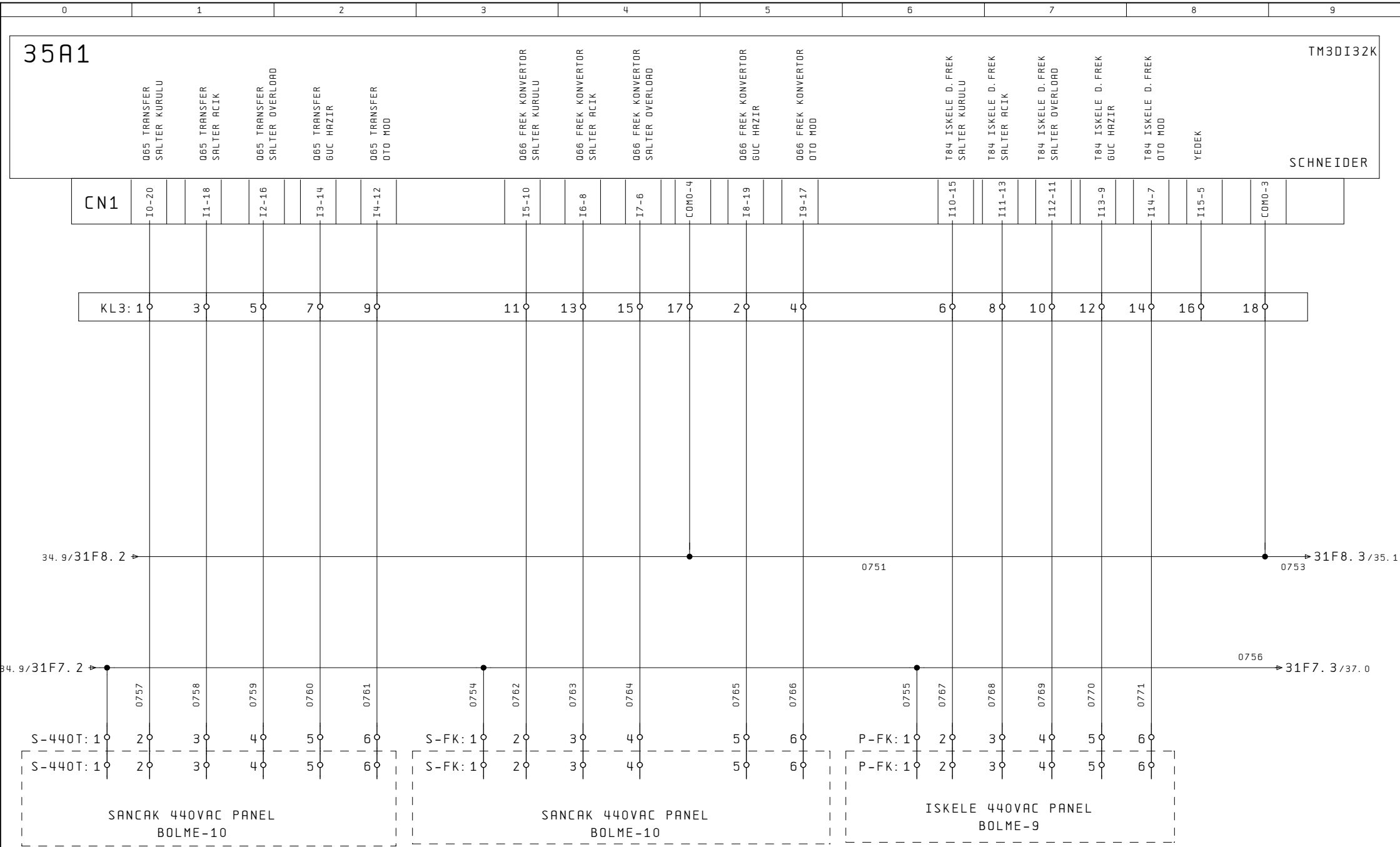

35

37



HILAL GEMİ MUHENDİSLİK
ELEKTRİK DONANIM VE OTOMASYON SAN. TİC. LTD. STİ
Gıptas San. Sitesi B/Blok No:30 İcmeler/TUZLA
Tel:0216 395 60 50 GSM:0539 648 88 05
www.hilalgemi.com

DATE
DRAWN BY
CHECKED BY

OTOMATİK KONTROL
BOLME-9

BESIKTAS SHIPYARD

YUZER HAVUZ 3

PROJE KOD	BSK/HLL-YH32	Page Number	36
CLASS	RINA	Highest Page Number	63

35A1

TM3DI32K

SCHNEIDER

T85 TRANSFER
SALTER KURULUT85 TRANSFER
SALTER ACIKT85 TRANSFER
SALTER OVERLOADT85 TRANSFER
GUC HAZIRT85 TRANSFER
OTO MODT91 TR3
SALTER KURULUT91 TR3
SALTER ACIKT91 TR3
SALTER OVERLOADT91 TR3
GUC HAZIRT91 TR3
OTO MODT92 TRANSFER 220VAC
SALTER KURULUT92 TRANSFER 220VAC
SALTER ACIKT92 TRANSFER 220VAC
SALTER OVERLOADT92 TRANSFER 220VAC
OTO MODT92 TRANSFER 220VAC
OTO MODISKELE 220VAC
INSULATION ALARM

CN2

I0-20

I1-18

I2-16

I3-14

I4-12

I5-10

I6-8

I7-6

COMO-4

I8-19

I9-17

I10-15

I11-13

I12-11

I13-9

I14-7

I15-5

COMO-3

KL4: 1 3 5 7 9 11 13 15 17 2 4 6 8 10 12 14 16 18

38. 9/31F8. 3

0774

31F8. 4/35. 9

0776

36. 9/31F7. 3

0796

31F7. 4/38. 0

0780

0781

0782

0783

0784

0777

0785

0786

0787

0788

0789

0778

0790

0791

0792

0793

0794

0779

0795

P-440T: 1 2 3 4 5 6

P-TR3: 1 2 3 4

P-220T: 1 2 3 4 5 6

P-440T: 1 2 3 4 5 6

P-TR3: 1 2 3 4

P-220T: 1 2 3 4 5 6

ISKELE 440VAC PANEL
BOLME-9ISKELE 220VAC PANEL
BOLME-11ISKELE 220VAC PANEL
BOLME-11

36

38



HILAL GEMİ MUHENDİSLİK
ELEKTRİK DONANIM VE OTOMASYON SAN. TİC. LTD. STİ
Gıptas San. Sitesi B/Blok No:30 İçmeler/TUZLA
Tel:0216 395 60 50 GSM:0539 648 88 05
www.hilalgemi.com

DATE
DRAWN BY
CHECKED BY

OTOMATİK KONTROL
BOLME-9

BESIKTAS SHIPYARD

YUZER HAVUZ 3

PROJE KOD
CLASSBSK/HLL-YH32
RINA

Page Number 37
Highest Page Number 63

36A1

TM3DI16K

SCHNEIDER

072 S-TR3
SALTER KURULU072 S-TR3
SALTER ACIK072 S-TR3
SALTER OVERLOAD072 S-TR3
GUC HAZIR072 S-TR3
OTO MOD073 S-TRNSF
SALTER KURULU073 S-TRNSF
SALTER ACIK073 S-TRNSF
SALTER OVERLOAD073 S-TRNSF
GUC HAZIR073 S-TRNSF
OTO MODSANCAK 220VAC
INSULATION ALARM

YEDEK

YEDEK

YEDEK

SANCAK ADP 400VAC
INSULATION ALARMISKELE ADP 400VAC
INSULATION ALARM

I0

I1

I2

I3

I4

I5

I6

I7

COM

I8

I9

I10

I11

I12

I13

I14

I15

COM

37.1/31F8.3

0804

0805

0801.1

0802.1

37.9/31F7.4

0807

0808

0809

0810

0811

0798

0812

0813

0814

0815

0816

0799

0817

0800

0801

0802

S-TR3: 1

S-220T: 1

S-TR3: 2

S-220T: 2

S-TR3: 3

S-220T: 3

S-TR3: 4

S-220T: 4

S-TR3: 5

S-220T: 5

S-TR3: 6

S-220T: 6

1

2

3

4

5

6

11

12

B9-1A: 31

32

B9-X1: 17

18

SANCAK 220VAC PANEL
BOLME-12SANCAK 220VAC PANEL
BOLME-12

38A2

10PORT

ETH1 → G1/24.5

ETH2 → G2/29.5

ETH3 → S-TR1/7.2

ETH4 → CPU-33A1 BOLME-9

ETH5

SUPPLY

24

24

+

-

37

39



HILAL GEMİ MUHENDİSLİK
ELEKTRİK DONANIM VE OTOMASYON SAN. TİC. LTD. STİ
Gıptas San. Sitesi B/Blok No:30 İcmeler/TUZLA
Tel:0216 395 60 50 GSM:0539 648 88 05
www.hilalgemi.com

DATE
DRAWN BY
CHECKED BY

OTOMATİK KONTROL
BOLME-9

BESİKTAS SHİPYARD

YUZER HAVUZ 3

PROJE KOD

BSK/HLL-YH32

Page Number

38

CLASS

RINA

Highest Page Number

63

33A1

TM241CE24T CPU

GEN-1 SALTER
KUR

GEN-1 SALTER
AC

GEN-1 FREKANS
ASAGI

GEN-1 FREKANS
YUKARI

GEN-1 VOLTAJ
ASAGI

GEN-1 VOLTAJ
YUKARI

GEN-1
START-STOP

GEN-2 SALTER
KUR

GEN-2 SALTER
AC

GEN-2 FREKANS
ASAGI

SCHNEIDER

VO+

VO-

Q0

Q1

Q2

Q3

V1+

V1-

Q4

Q5

Q6

Q7

V2+

V2-

Q8

Q9

31.9/31F9

0818

0834

0835

0836

0837

0838

0839

0840

0841

0842

0843

0819

0820

31F9. 1/40. 0

31.9/31F10

0821

0822

0823

0824

0825

0826

0827

0828

0829

0830

0831

0832

0833

31F10. 1/40. 0

RPM21BD

RPM21BD

RSB2A080BD

RSB2A080BD

RSB2A080BD

RSB2A080BD

RSB2A080BD

RPM21BD

RPM21BD

RSB2A080BD

. 11 -	14	25.	211 -	14	25.	311 -	12	11 -	12
11 -	12	11 -	12	. 11 -	14	27.	111 -	14	27. 2
. 41 -	44	. 41 -	44	. 21 -	22	21 -	22	21 -	22
41 -	42	41 -	42	. 21 -	24	. 21 -	24		

11 -	12	11 -	12	11 -	12	11 -	12	11 -	14	30. 3
. 11 -	14	27. 3	11 -	14	27. 3	11 -	14	27. 8	11 -	12
21 -	22	21 -	22	21 -	22	21 -	22	. 41 -	44	
. 21 -	24	. 21 -	24	. 21 -	24	27. 8	41 -	42		

. 11 -	14	30. 4	11 -	12
11 -	12	. 11 -	14	32. 1
. 41 -	44	21 -	22	
41 -	42	. 21 -	24	



37A1

TM3DQ16R

SCHNEIDER

GEN-2 FREKANS
YUKARI

GEN-2 VOLTRAJ
ASAGI

GEN-2 VOLTRAJ
YUKARI

GEN-2
START-STOP

Q1 S-TR1 SALTER
KUR

Q1 S-TR1 SALTER
AC

Q41 P-TRNS SALTER
KUR

Q41 P-TRNS SALTER
AC

Q0

Q1

Q2

Q3

Q4

Q5

Q6

Q7

COMO

COMO

39.9/31F9.1 → 0844 0845 → 31F9.2/41.0

39.9/31F10.1 → 0846 0847 0848 0849 0850 0851 0852 0853 → 31F10.2/41.0

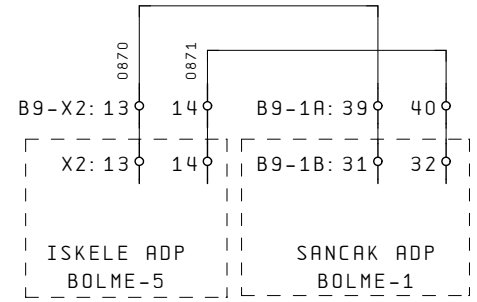
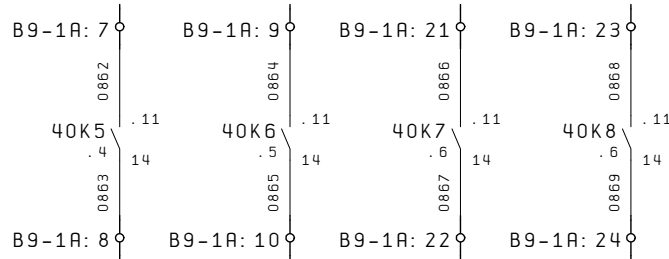
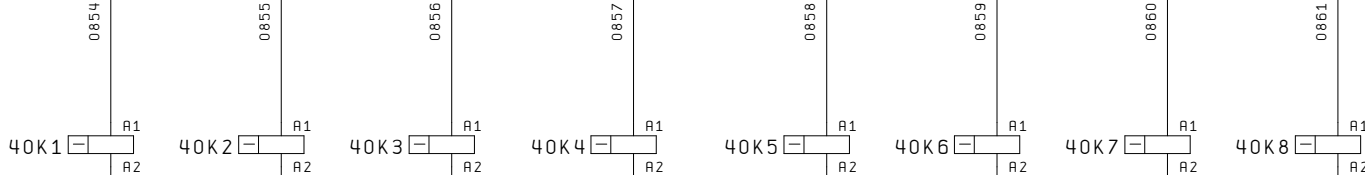

RSB2A080BD	RSB2A080BD	RSB2A080BD	RSB2A080BD	RPM21BD	RPM21BD	RPM21BD	RPM21BD
11 / 12	11 / 12	11 / 12	11 / 12	11 / 14 .4	11 / 14 .5	11 / 14 .6	11 / 14 .6
.11 / 14 32.2	.11 / 14 32.3	.11 / 14 32.3	.11 / 14 32.8	.11 / 12	.11 / 12	.11 / 12	.11 / 12
21 / 22	21 / 22	21 / 22	21 / 22	.41 / 44	.41 / 44	.41 / 44	.41 / 44
.21 / 24	.21 / 24	.21 / 24	.21 / 24 32.9	41 / 42	41 / 42	41 / 42	41 / 42



HILAL GEMİ MUHENDİSLİK
ELEKTRİK DONANIM VE OTOMASYON SAN. TİC. LTD. STİ
Gölpazarı San. Sitesi B/Blok No:30 İçmeler/TUZLA
Tel:0216 395 60 50 GSM:0539 648 88 05
www.hilalgemi.com

DATE
DRAWN BY
CHECKED BY

OTOMATİK KONTROL
BOLME-9

BESIKTAS SHIPYARD

YUZER HAVUZ 3

PROJE KOD	BSK/HLL-YH32	Page Number	40
CLASS	RINA	Highest Page Number	63

37A1

TM3DQ16R

SCHNEIDER

T1 P-TR1
KUR
SALTERT1 P-TR1
AC
SALTERT38 P-TRNS
KUR
SALTERT38 P-TRNS
AC
SALTERQ63 SANCRAK ADP
SALTER KURQ63 SANCRAK ADP
SALTER ACQ64 TR2
SALTER KURQ64 TR2
SALTER AC

Q8

Q9

Q10

Q11

Q12

Q13

Q14

Q15

COM1

COM1

40.8/31F9.2 → 31F9.3/42.0

0872 0873

0882

0883

0884

0885

0886

0887

0888

0889

41K1

41K2

41K3

41K4

41K5

41K6

41K7

41K8

40.8/31F10.2 → 31F10.3/42.0

0874

0875

0876

0877

0878

0879

0880

0881

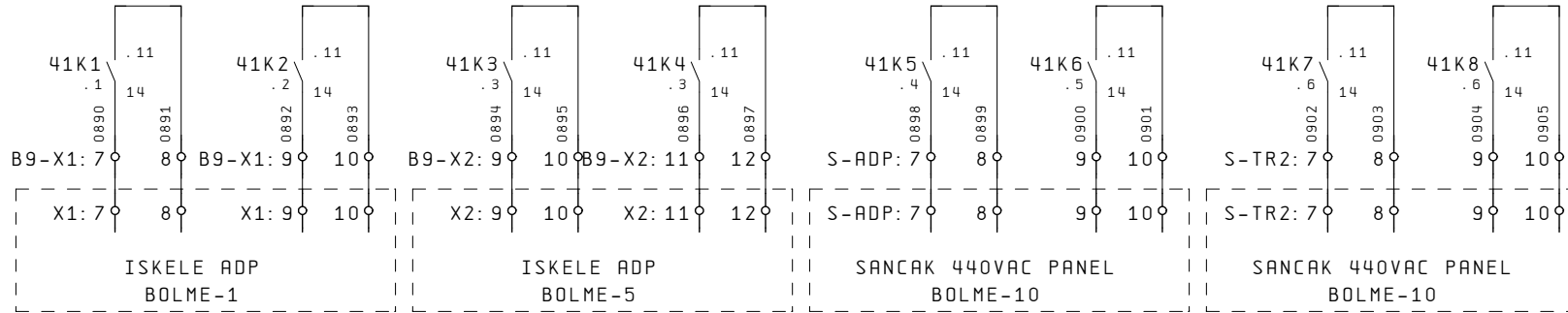

RPM218D

RPM218D

RPM218D

RPM218D

RPM218D

RPM218D

RPM218D

RPM218D

.11	-	14	.1
11	-	12	
.41	-	44	
41	-	42	

.11	-	14	.1
11	-	12	
.41	-	44	
41	-	42	

.11	-	14	.2
11	-	12	
.41	-	44	
41	-	42	

.11	-	14	.3
11	-	12	
.41	-	44	
41	-	42	

.11	-	14	.4
11	-	12	
.41	-	44	
41	-	42	

.11	-	14	.5
11	-	12	
.41	-	44	
41	-	42	

.11	-	14	.6
11	-	12	
.41	-	44	
41	-	42	

.11	-	14	.7
11	-	12	
.41	-	44	
41	-	42	

38A1

TM3DQ16R

SCHNEIDER

065 TRMS
SALTER KUR065 TRMS
SALTER AC066 SANCAK FREK
SALTER KUR066 SANCAK FREK
SALTER ACT84 ISKELE D. FREK
SALTER KURT84 ISKELE D. FREK
SALTER ACT85 TRANSFER
SALTER KURT85 TRANSFER
SALTER AC

Q0

Q1

Q2

Q3

Q4

Q5

Q6

Q7

COMO

COMO

41. 8/31F9. 3

31F9. 4/43. 0

0906 0907

0916

0917

0918

0919

0920

0921

0922

0923

42K1

42K2

42K3

42K4

42K5

42K6

42K7

42K8

41. 8/31F10. 3

31F10. 4/43. 0

0908

0909

0910

0911

0912

0913

0914

0915

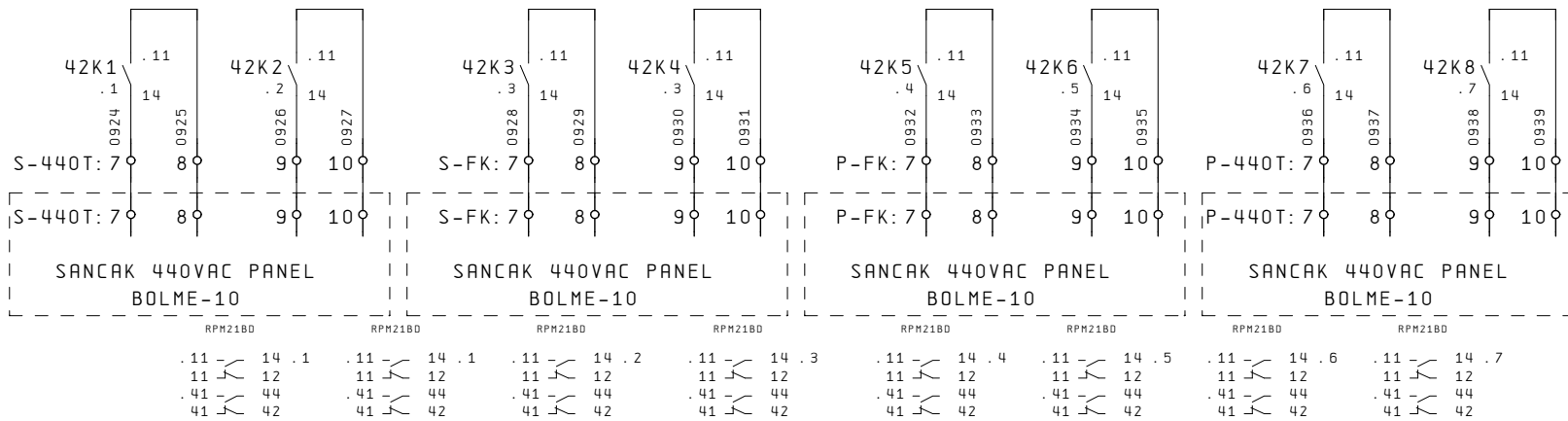

11 - 14 . 1
11 - 12
. 41 - 44
41 - 42

11 - 14 . 1
11 - 12
. 41 - 44
41 - 42

11 - 14 . 2
11 - 12
. 41 - 44
41 - 42

11 - 14 . 3
11 - 12
. 41 - 44
41 - 42

11 - 14 . 4
11 - 12
. 41 - 44
41 - 42

11 - 14 . 5
11 - 12
. 41 - 44
41 - 42

11 - 14 . 6
11 - 12
. 41 - 44
41 - 42

11 - 14 . 7
11 - 12
. 41 - 44
41 - 42

41

43



HILAL GEMİ MUHENDİSLİK
ELEKTRİK DONANIM VE OTOMASYON SAN. TİC. LTD. STİ
Gıptas San. Sitesi B/Blok No:30 İcmeler/TUZLA
Tel:0216 395 60 50 GSM:0539 648 88 05
www.hilalgemi.com

DATE
DRAWN BY
CHECKED BY

OTOMATİK KONTROL
BOLME-9

BEŞİKTAS SHİPYARD

YUZER HAVUZ 3

PROJE KOD

BSK/HLL-YH32

Page Number

42

CLASS

RINA

Highest Page Number

63

38A1

TM3DQ16R

SCHNEIDER

T91 TR3
SALTER KUR

T91 TR3
SALTER AC

T92 TRANSFER 220VAC
SALTER KUR

T92 TRANSFER 220VAC
SALTER AC

072 TR3
SALTER KUR

072 TR3
SALTER AC

16P1 ER YON
041 AKIM

16P1 ER YON
T38 AKIM

Q8

Q9

Q10

Q11

Q12

Q13

Q14

Q15

COM1

COM1

42. 8/31F9. 4

31F9. 5/44. 1

0954

0955

0956

0957

0958

0959

0960

0961

0940

0941

0942

0943

43K7 .11
.6 14

43K8 .11
.7 14

43K1 A1
A2

43K2 A1
A2

43K3 A1
A2

43K4 A1
A2

43K5 A1
A2

43K6 A1
A2

43K7 A1
A2

43K8 A1
A2

42. 8/31F10. 4

31F10. 5/44. 1

0944

0945

0946

0947

0948

0949

0950

0951

0952

0953

43K1 .11
.1 14

43K2 .11
.2 14

43K3 .11
.3 14

43K4 .11
.3 14

43K5 .11
.4 14

43K6 .11
.5 14

0962
B9-1A: 19 20

0963
B9-X2: 1 2

P-TR3: 7 8

P-TR3: 7 8

P-220T: 7 8

P-220T: 7 8

S-TR3: 7 8

S-TR3: 7 8

S-TR3: 7 8

P-TR3: 7 8

P-TR3: 7 8

P-220T: 7 8

P-220T: 7 8

S-TR3: 7 8

S-TR3: 7 8

S-TR3: 7 8

ISKELE 220VAC PANEL
BOLME-11

ISKELE 220VAC PANEL
BOLME-11

SANCAK 220VAC PANEL
BOLME-12

RPM218D

RPM218D

RPM218D

RPM218D

RPM218D

RPM218D

RPM218D

RPM218D

.11 - 14 .1
11 - 12
.41 - 44
41 - 42

.11 - 14 .1
11 - 12
.41 - 44
41 - 42

.11 - 14 .2
11 - 12
.41 - 44
41 - 42

.11 - 14 .3
11 - 12
.41 - 44
41 - 42

.11 - 14 .4
11 - 12
.41 - 44
41 - 42

.11 - 14 .5
11 - 12
.41 - 44
41 - 42

.11 - 14 .7
11 - 12
.41 - 44
41 - 42

.11 - 14 .8
11 - 12
.41 - 44
41 - 42



39A1

TM3DQ16R

073 S-TRNS
SALTER KUR

073 S-TRNS
SALTER AC

PREF. TRIP-1
SANCAK

PREF. TRIP-2
SANCAK

PREF. TRIP-3
SANCAK

PREF. TRIP-4
SANCAK

PREF. TRIP-5
SANCAK

PREF. TRIP-1
ISKELE

SCHNEIDER

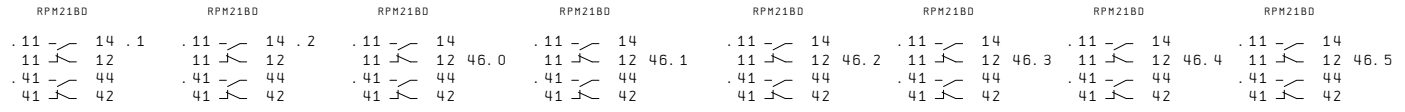
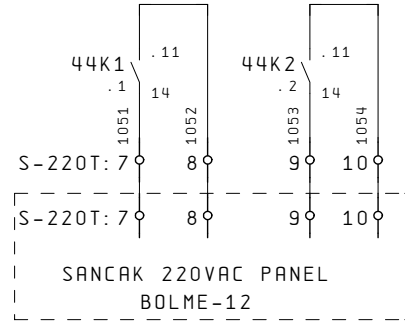
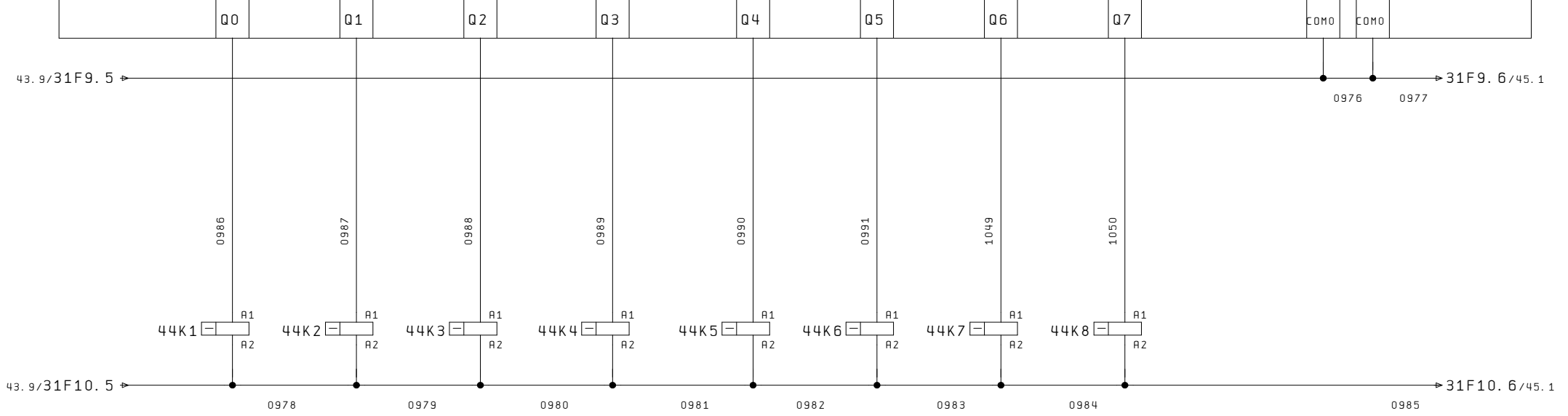

HILAL GEMİ MUHENDİSLİK
ELEKTRİK DONANIM VE OTOMASYON SAN. TİC. LTD. STİ
Gıptas San. Sitesi B/Blok No:30 İcmeler/TUZLA
Tel:0216 395 60 50 GSM:0539 648 88 05
www.hilalgemi.com

DATE
DRAWN BY
CHECKED BY

BESIKTAS SHIPYARD

PROJE KOD
CLASS

YUZER HAVUZ 3
BSK/HLL-YH32
RINA

Page Number 44
Highest Page Number 63

39A1

TM3DQ16R

SCHNEIDER

PREF. TRIP-2
ISKELEPREF. TRIP-3
ISKELEPREF. TRIP-4
ISKELEPREF. TRIP-5
ISKELEJEN-1 SYNC
OKEYJEN-2 SYNC
OKEY

SIREN ÇIKIŞI

Q8

Q9

Q10

Q11

Q12

Q13

Q14

Q15

COM1

COM1

44.9/31F9.6

0990

0991

31F9.7/47.1

1000

1001

1002

1003

1004

1005

1006

1007

31.9/45F2

31.9/45F1

45K7 .21 45K7 .11
.6 24 .6 1445K1 A1
A245K2 A1
A245K3 A1
A245K4 A1
A245K5 A1
A245K6 A1
A245K7 A1
A245K8 A1
A2

31F10.7/47.1

0992

0993

0994

0995

0996

0997

0998

0999

SIREN 4A 4A
45F1 45F2

45B1

ISKELE VE KONTROL ODASI
SIREN BESLEME

RPM218D

RPM218D

RPM218D

RPM218D

RPM218D

RPM218D

RPM218D

RPM218D

.11 - 14
11 - 12 46.6
.41 - 44
41 - 42.11 - 14
11 - 12 46.7
.41 - 44
41 - 42.11 - 14
11 - 12 46.8
.41 - 44
41 - 42.11 - 14
11 - 12 46.9
.41 - 44
41 - 42.11 - 14 28.2
11 - 12
.41 - 44
41 - 42.11 - 14 28.3
11 - 12
.41 - 44
41 - 42.11 - 14 .9
.21 - 24 .8
11 - 12
.41 - 44
41 - 42.11 - 14
11 - 12
.41 - 44
41 - 42

44

46



HILAL GEMİ MUHENDİSLİK
ELEKTRİK DONANIM VE OTOMASYON SAN. TİC. LTD. STİ
Gıptas San. Sitesi B/Blok No:30 İcmeler/TUZLA
Tel:0216 395 60 50 GSM:0539 648 88 05
www.hilalgemi.com

DATE
DRAWN BY
CHECKED BY

BESIKTAS SHIPYARD

YUZER HAVUZ 3

PROJE KOD

BSK/HLL-YH32

Page Number

45

CLASS

RINA

Highest Page Number

63

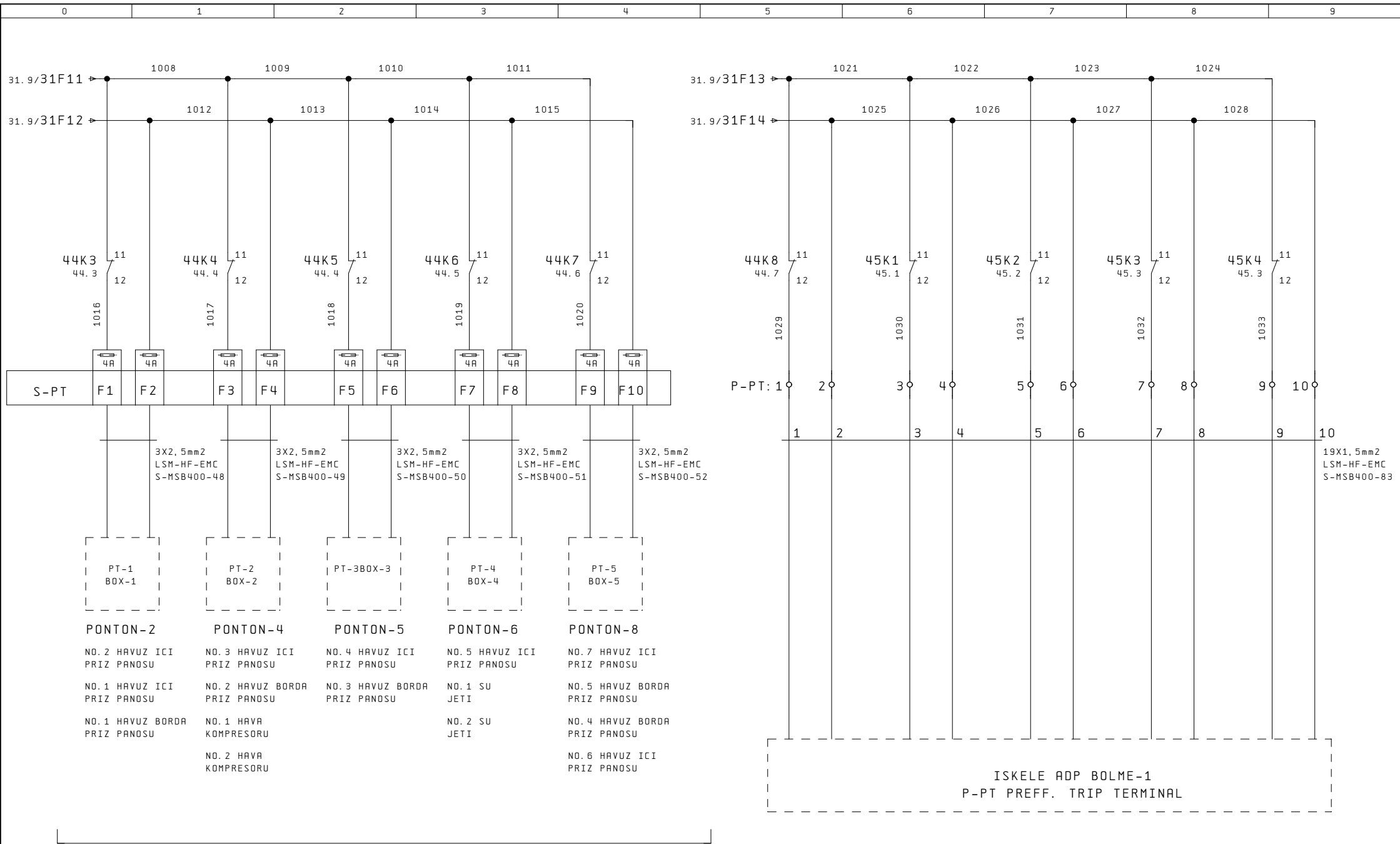

SANCAR MAHAL PREF. TRIP BOX LISTESİ

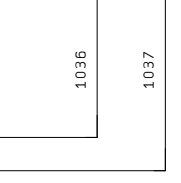
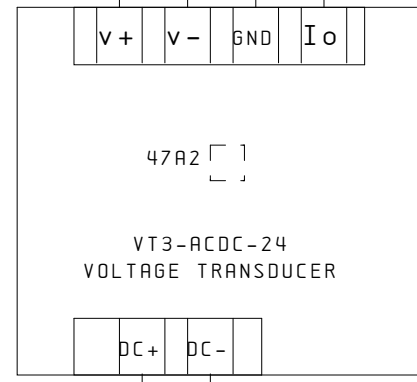
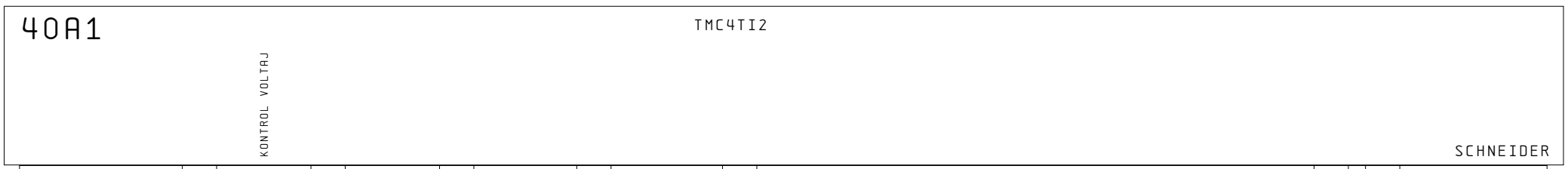

45.9/31F9.7
45.7/31F10.7



HILAL GEMİ MUHENDİSLİK
ELEKTRİK DONANIM VE OTOMASYON SAN. TİC. LTD. STİ
Gıptas San. Sitesi B/Blok No:30 İcmeler/TUZLA
Tel:0216 395 60 50 GSM:0539 648 88 05
www.hilalgemi.com

DATE	
DRAWN BY	
CHECKED BY	

BESIKTAS SHIPYARD

YUZER HAVUZ 3

PROJE KOD	BSK/HLL-YH32	Page Number 47
CLASS	RINA	Highest Page Number 63

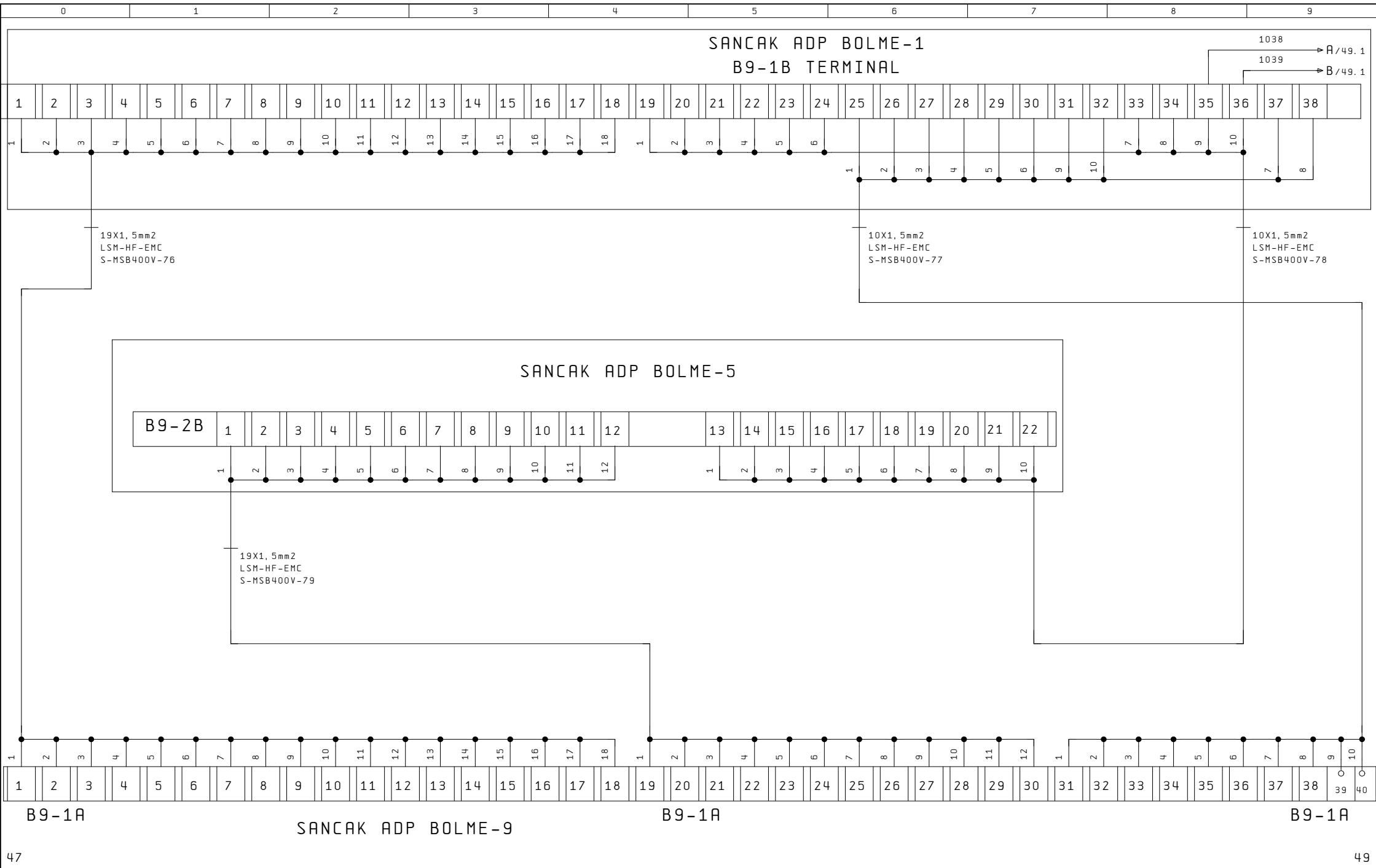

48.9/B
48.9/A

SANCAK ADP BOLME-1
X1 TERMINAL

X1	1	2	3	4	5	6
----	---	---	---	---	---	---

1 2 3 4 5 6

ISKELE ADP BOLME-1 X1 TERMINAL
10X1, 5mm2 LSM-HF-EMC P-MSB400V-83

SANCAK ADP BOLME-9
B9-X2 TERMINAL

B9-X2	1	2	3	4	5	6	7	8	9	10	11	12	13	14
-------	---	---	---	---	---	---	---	---	---	----	----	----	----	----

1 2 3 4 5 6 7 8 9 10 11 12 13 14

ISKELE ADP BOLME-5 X2 TERMINAL
19X1, 5mm2 LSM-HF-EMC P-MSB400V-59

SANCAK ADP BOLME-1
XK TERMINAL

XK	1	2	3	4
----	---	---	---	---

1 2 3 4

SANCAK KOMPANZASYON PANOSU BOLME-13
4X1, 5mm2 LSM-HF-EMC S-MSB400V-80



DATE	
DRAWN BY	
CHECKED BY	

SANCAK ADP BOLME-9
B9-X1 TERMINAL

YEDEK
YEDEK

SANCAK ADP 400VAC
BOLME-5

SANCAK ADP 400VAC
BOLME-1

SANCAK
ADP 400VAC
BOLME-9

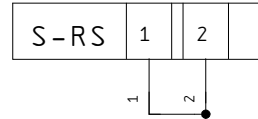
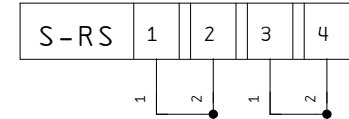
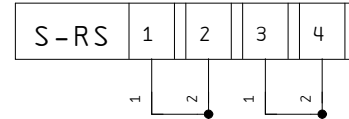
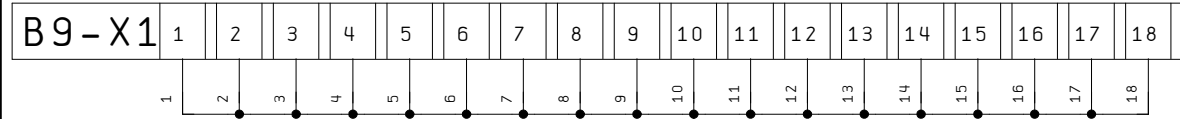

ISKELE ADP BOLME-1 X1 TERMINAL
19X1, 5mm2 LSM-HF-EMC P-MSB400V-58

SANCAK 440VAC PANEL BOLME-10
3X1, 5mm2 LSM-HF-EMC S-RS2
SANCAK 400VAC ADP PANEL BOLME-1
3X1, 5mm2 LSM-HF-EMC S-RS3

SANCAK 400VAC ADP PANEL BOLME-5
3X1, 5mm2 LSM-HF-EMC S-RS3
SANCAK 400VAC ADP PANEL BOLME-9
3X1, 5mm2 LSM-HF-EMC S-RS4

SANCAK 400VAC ADP PANEL BOLME-1
3X1, 5mm2 LSM-HF-EMC S-RS4



DATE	
DRAWN BY	
CHECKED BY	

BESIKTAS SHIPYARD

YUZER HAVUZ 3	
PROJE KOD	BSK/HLL-YH32
CLASS	RINA

=	
+	
Page Number	50
Highest Page Number	63

SANCAK ADP BOLME-8
J1 TERMINAL

J1	1	2	3	4	5	6	7	8	9	10	11	12	13	14	15	16	17	18
----	---	---	---	---	---	---	---	---	---	----	----	----	----	----	----	----	----	----

1	2	3	4	5	6	7	8	9	10	11	12	13	14	15	16
---	---	---	---	---	---	---	---	---	----	----	----	----	----	----	----

JENERATOR-1 PANEL TERMINALI

19X1, 5mm2 LSM-HF-EMC S-MSB400V-40

JENERATOR-1 ALTERNATOR ISITICISI

3X1, 5mm2 LSM-HF-EMC S-MSB400V-38

SANCAK ADP BOLME-9
J2 TERMINAL

J2	1	2	3	4	5	6	7	8	9	10	11	12	13	14	15	16	17	18
----	---	---	---	---	---	---	---	---	---	----	----	----	----	----	----	----	----	----

1	2	3	4	5	6	7	8	9	10	11	12	13	14	15	16
---	---	---	---	---	---	---	---	---	----	----	----	----	----	----	----

JENERATOR-2 PANEL TERMINALI

19X1, 5mm2 LSM-HF-EMC S-MSB400V-44

JENERATOR-2 ALTERNATOR ISITICISI

3X1, 5mm2 LSM-HF-EMC S-MSB400V-42

SANCAK ADP BOLME-8
JB TERMINAL

JB	1	2	3	4	5	6
----	---	---	---	---	---	---

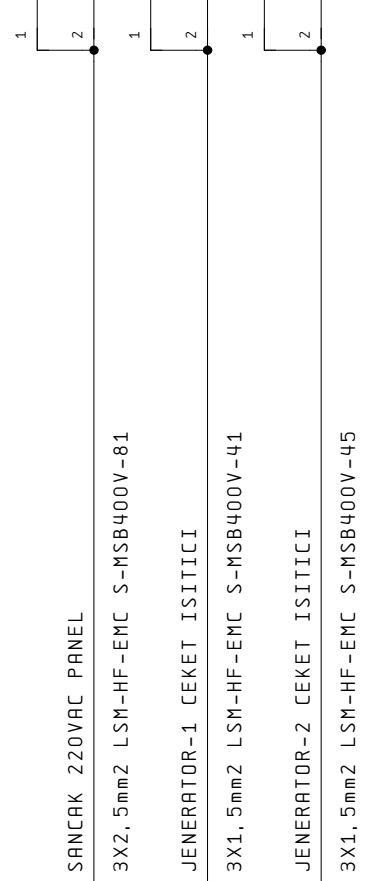

SANCAK ADP BOLME-1
X2 TERMINAL

X2	1	2	3	4	5	6	7	8	9	10
----	---	---	---	---	---	---	---	---	---	----



SANCAK ADP BOLME-9
S-FK TERMINAL

S-FK	1	2	3	4	5	6	7	8	9	10
------	---	---	---	---	---	---	---	---	---	----

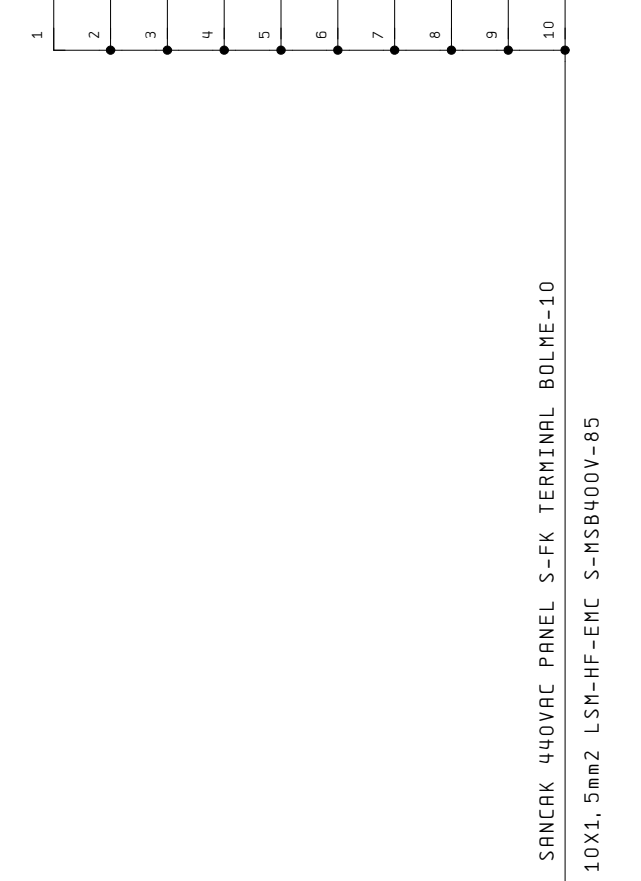

DATE	
DRAWN BY	
CHECKED BY	

--	--

BESIKTAS SHIPYARD

YUZER HAVUZ 3	
PROJE KOD	BSK/HLL-YH32
CLASS	RINA

Page Number	52
Highest Page Number	63

SANCAK ADP PANEL
BOLME-9 TERMINAL

S-ADP 1 2 3 4 5 6 7 8 9 10

1 2 3 4 5 6 7 8 9 10

SANCAK 440VAC PANEL S-ADP TERMINAL BOLME-10
10X1, 5mm2 LSM-HF-EMC S-MSB400V-86

S-TR2 1 2 3 4 5 6 7 8 9 10

1 2 3 4 5 6 7 8 9 10

SANCAK 440VAC PANEL S-TR2 TERMINAL BOLME-10
10X1, 5mm2 LSM-HF-EMC S-MSB400V-87

S-440T 1 2 3 4 5 6 7 8 9 10

1 2 3 4 5 6 7 8 9 10

SANCAK 440VAC PANEL S-440T TERMINAL BOLME-10
10X1, 5mm2 LSM-HF-EMC S-MSB400V-88



SANCAK ADP
BOLME-9 TERMINAL

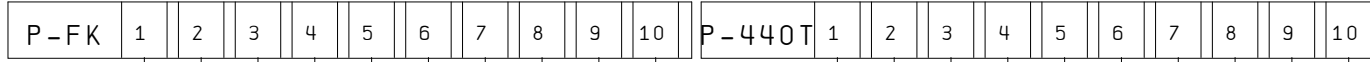

ISKELE 440VAC PANEL BOLME-9 P-FK TERMINAL

10X1, 5mm2 LSM-HF-EMC S-MSB400V-89

ISKELE 440VAC PANEL BOLME-9 P-440T TERMINAL

10X1, 5mm2 LSM-HF-EMC S-MSB400V-90



SANCAK ADP
BOLME-9 TERMINAL

SANCAK ADP BOLME-9
XF TERMINAL

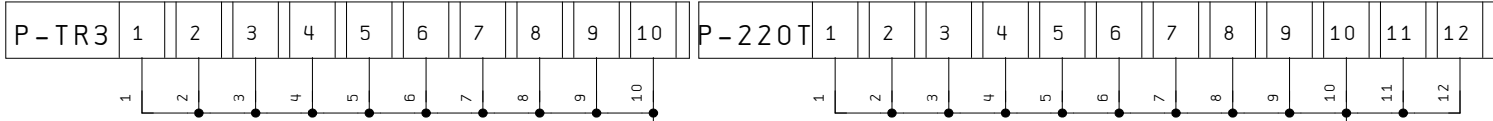

ISKELE 220VAC PANEL BOLME-11 P-TR3 TERMINAL

10X1, 5mm2 LSM-HF-EMC S-MSB400V-91

ISKELE 220VAC PANEL BOLME-11 P-220T TERMINAL

19X1, 5mm2 LSM-HF-EMC S-MSB400V-92

SANCAK FAN PANEL

4X1, 5mm2 LSM-HF-EMC S-MSB400V-151



SANCAK ADP BOLME-9

SANCAK ADP BOLME-1

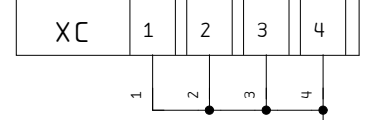
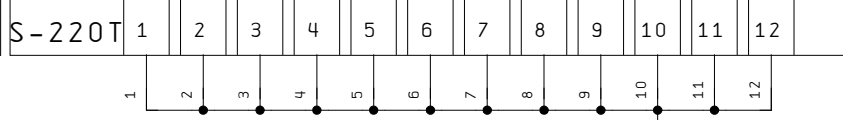
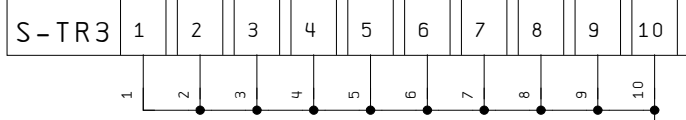

SANCAK 220VAC PANEL BOLME-12 P-TR3 TERMINAL

10X1, 5mm2 LSM-HF-EMC S-MSB400V-93

SANCAK 220VAC PANEL BOLME-12 S-220T TERMINAL

19X1, 5mm2 LSM-HF-EMC S-MSB400V-94

4X1, 5mm2 LSM-HF-EMC S-MSB400V-150

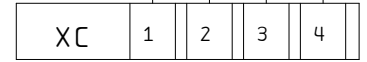

SANCAK ADP BOLME-5



DATE	
DRAWN BY	
CHECKED BY	

Bill of materials

Item	Amount	Designation	Type	Manufacturer	Article number	Note
Q1	1			SCHNEIDER	NW40H1 3P MLZEHH	
5CT1	1	AKIMTRAFOSU 4000/5A		SEZGIN	4000/5A 10 VA	
5CT4	1	AKIMTRAFOSU 4000/5A		SEZGIN	4000/5A 10 VA	
5CT2	1	AKIMTRAFOSU 4000/5A		SEZGIN	4000/5A 10 VA	
5CT5	1	AKIMTRAFOSU 4000/5A		SEZGIN	4000/5A 10 VA	
5CT3	1	AKIMTRAFOSU 4000/5A		SEZGIN	4000/5A 10 VA	
5CT6	1	AKIMTRAFOSU 4000/5A		SEZGIN	4000/5A 10 VA	
5F1	1			SCHNEIDER	DF103	
5F1	3			SCHNEIDER	DF2CN10 10A	
5F6	1			SCHNEIDER	DF103	
5F6	3			SCHNEIDER	DF2CN10 10A	
5K1	1			SCHNEIDER	CAD-32-V7	
5P6	1	INSULATION MONITOR	T3200	SELCO	INSULATION MONITOR 400V	
5P5	1	METSEP	ENERGY ANALYZER	Telemecanique	METSEPM5110	
5P1	1			ISKRA	KILOWATTMETER 0-2000 KW	
5S2	1	VOLTMETER SELECTOR SWITCH	K1D024MLH	SCHNEIDER	K1D024MLH	
5P3	1	VOLTMETER	EC3V (96X96) DIRECT	ISKRA	VOLTMETER 0-500 V 96X96	
5F2	1	SIGORTALI KLEMENS 6mm2 6.3A	351 109	KLEMSAN	ASK 2S	
5F3	1	SIGORTALI KLEMENS 6mm2 6.3A	351 109	KLEMSAN	ASK 2S	
5P4	1	FREQUENCYMETER	FC3A (96X96)	ISKRA	FREQ. METER 96-96 45-55HZ	
5TR1	1	TRANSFORMER	400/230V 500VA	AGPLUS	400/230V 500VA	
5S1	1	AMPERMETER SELECTOR SWITCH	K1F003MLH	SCHNEIDER	K1F003MLH	
5F4	1	SIGORTALI KLEMENS 6mm2 6.3A	351 109	KLEMSAN	ASK 2S	
5F5	1	SIGORTALI KLEMENS 6mm2 6.3A	351 109	KLEMSAN	ASK 2S	
5P2	1			ISKRA	AMMETER 0-4000/5A	
6S1	1			SCHNEIDER	XB5-AR31	
6S2	1	PUSH BUTTON	XB5-AR42	Telemecanique	XB5-AR42	
6K1	1			SCHNEIDER	RXM4AB1P7	
6K4	1			SCHNEIDER	RXM4AB1P7	
6K2	1			SCHNEIDER	RXM4AB1P7	
6K3	1			SCHNEIDER	RXM4AB1P7	
7D1	1	DIOD MODUL 6	113 060	KLEMSAN	DM 6-S	
7H1	1	INDICATING LAMP GREEN	XB7-EV03BP	Telemecanique	XB7-EV03BP	
7A3	1			SCHNEIDER	HMIGX05500 10'' TOUCH	
7H2	1	INDICATING LAMP WHITE	XB7-EV07BP	Telemecanique	XB7-EV07BP	
7S1	1	PUSH BUTTON	XB5-AC21	Telemecanique	XB5-AC21	
7S2	1	SELECTOR SWITCH	XB5-AK125B5	Telemecanique	XB5-AK125B5	
7K1	1			SCHNEIDER	RXM4AB1BD	
7F2	1	SIGORTALI KLEMENS 6mm2 6.3A	351 109	KLEMSAN	ASK 2S	
7F1	1	MINIATURE CIRCIUT BREAKER 20A	C60N 2P	SCHNEIDER	A9F74220	
7A1	1	20A POWER SUPPLY	QUNIT-PS-240AC/24DC/20	Phoneix Contact	PS-100-240AC/24DC/20	
7A2	1			APC	UPS 220VAC 1,5KVA	
7F3	1	SIGORTALI KLEMENS 6mm2 6.3A	351 109	KLEMSAN	ASK 2S	
7F6	1	MINIATURE CIRCIUT BREAKER 10A	C60N 2P	SCHNEIDER	A9F74210	
7F4	1	SIGORTALI KLEMENS 6mm2 6.3A	351 109	KLEMSAN	ASK 2S	
7F5	1	SIGORTALI KLEMENS 6mm2 6.3A	351 109	KLEMSAN	ASK 2S	
7F7	1	MINIATURE CIRCIUT BREAKER 10A	C60N 2P	SCHNEIDER	A9F74210	
Q4	1	CIRCUIT BREAKER NS	33466S2	Telemecanique	NS800N	
Q5	1	CIRCUIT BREAKER NS	33466S2	Telemecanique	NS800N	
Q6	1	CIRCUIT BREAKER NS	33466S2	Telemecanique	NS800N	

Bill of materials

Item	Amount	Designation	Type	Manufacturer	Article number	Note
Q7	1	CIRCUIT BREAKER NS	33466S2	Telemecanique	NS800N	
Q8	1	CIRCUIT BREAKER NS	33466S2	Telemecanique	NS800N	
Q9	1	CIRCUIT BREAKER NSX400N	NSX400N	Telemecanique	LV432693	
Q10	1	CIRCUIT BREAKER NSX400N	NSX400N	Telemecanique	LV432693	
Q11	1	CIRCUIT BREAKER NSX400N	NSX400N	Telemecanique	LV432693	
Q12	1	CIRCUIT BREAKER NSX400N	NSX400N	Telemecanique	LV432693	
Q13	1	CIRCUIT BREAKER NSX	TM100D	Telemecanique	LV429840	
Q14	1	CIRCUIT BREAKER NSX	TM100D	Telemecanique	LV429840	
Q15	1	CIRCUIT BREAKER NSX	TM100D	Telemecanique	LV429840	
Q16	1	CIRCUIT BREAKER NSX	TM100D	Telemecanique	LV429840	
Q17	1	CIRCUIT BREAKER NSX	TM100D	Telemecanique	LV429840	
Q18	1	CIRCUIT BREAKER NSX	TM100D	Telemecanique	LV429840	
Q19	1	CIRCUIT BREAKER NSX	TM100D	Telemecanique	LV429840	
Q20	1	CIRCUIT BREAKER NSX	TM200D	Telemecanique	LV431831	
Q21	1	CIRCUIT BREAKER NSX	TM250D	Telemecanique	LV431830	
Q22	1	CIRCUIT BREAKER NSX	TM250D	Telemecanique	LV431830	
Q23	1	CIRCUIT BREAKER NSX630N	NSX630N	Telemecanique	LV432876	
Q24	1	CIRCUIT BREAKER NSX400N	NSX400N	Telemecanique	LV432693	
Q25	1	CIRCUIT BREAKER NSX630N	NSX630N	Telemecanique	LV432876	
Q26	1	CIRCUIT BREAKER NSX	TM160D	Telemecanique	LV430840	
Q27	1	CIRCUIT BREAKER NSX	TM160D	Telemecanique	LV430840	
Q28	1	CIRCUIT BREAKER NSX	TM100D	Telemecanique	LV429840	
Q29	1	CIRCUIT BREAKER NSX	TM250D	Telemecanique	LV431830	
Q30	1	CIRCUIT BREAKER NSX	TM100D	Telemecanique	LV429840	
Q31	1	CIRCUIT BREAKER NSX	TM160D	Telemecanique	LV430840	
Q32	1	CIRCUIT BREAKER NSX	TM200D	Telemecanique	LV431831	
Q33	1	CIRCUIT BREAKER NSX	TM100D	Telemecanique	LV429840	
Q34	1	CIRCUIT BREAKER NSX	TM160D	Telemecanique	LV430840	
Q35	1	CIRCUIT BREAKER NSX	TM100D	Telemecanique	LV429840	
Q36	1	CIRCUIT BREAKER NSX	TM100D	Telemecanique	LV429840	
Q37	1	CIRCUIT BREAKER NSX	TM100D	Telemecanique	LV429840	
Q38	1	CIRCUIT BREAKER NSX	TM100D	Telemecanique	LV429840	
Q39	1	CIRCUIT BREAKER NSX	TM100D	Telemecanique	LV429840	
Q40	1	CIRCUIT BREAKER NSX	TM250D	Telemecanique	LV431830	
Q41	1			SCHNEIDER	NW20H1 3P ML2EHH	
16CT1	1	CURRENT TRANSFORMER	2000/5A 10 VA	SEZGIN	2000/5A 10 VA	
16CT2	1	CURRENT TRANSFORMER	2000/5A 10 VA	SEZGIN	2000/5A 10 VA	
16CT3	1	CURRENT TRANSFORMER	2000/5A 10 VA	SEZGIN	2000/5A 10 VA	
16F1	1			SCHNEIDER	DF103	
16F1	3			SCHNEIDER	DF2CN10 10A	
16F2	1			SCHNEIDER	DF103	
16F2	3			SCHNEIDER	DF2CN10 10A	
16P1	1	METSEP	ENERGY ANALYZER	SCHNEIDER	METSEPM5110	
16K1	1			SCHNEIDER	RPM21BD	
16K2	1			SCHNEIDER	RPM21BD	
16K3	1			SCHNEIDER	RPM21BD	
17K1	1			SCHNEIDER	CAD-32-V7	
17K2	1			SCHNEIDER	CAD-32-V7	
17K3	1			SCHNEIDER	CAD-32-V7	
17A1	1			PHOENIX	ETHERNET HUB	

 HILAL GEMI MUHENDISLIK ELEKTRIK DONANIM VE OTOMASYON SAN. TIC. LTD. STI Gıptas San. Sitesi B/Blok No:30 İcmeier/TUZLA Tel:0216 395 60 50 GSM:0539 648 88 05 www.hilalgemi.com	DATE		BESIKTAS SHIPYARD	YUZER HAVUZ 3	=		
	DRAWN BY						
	CHECKED BY			PROJE KOD	BSK/HLL-YH32	Page Number	58
				CLASS	RINA	Highest Page Number	63

Bill of materials

Item	Amount	Designation	Type	Manufacturer	Article number	Note
17F1	1	SIGORTALI KLEMENS 6mm2 6.3A	351 109	KLEMSAN	ASK 2S	
17F2	1	SIGORTALI KLEMENS 6mm2 6.3A	351 109	KLEMSAN	ASK 2S	
17TR1	1	TRANSFORMER	400/230V 500VA	AGPLUS	400/230V 500VA	
17F3	1	SIGORTALI KLEMENS 6mm2 6.3A	351 109	KLEMSAN	ASK 2S	
17F4	1	SIGORTALI KLEMENS 6mm2 6.3A	351 109	KLEMSAN	ASK 2S	
18S1	1			SCHNEIDER	XB5-AR31	
18S2	1	PUSH BUTTON	XB5-AR42	Telemecanique	XB5-AR42	
18K1	1			SCHNEIDER	RXM4AB1P7	
18K2	1			SCHNEIDER	RXM4AB1P7	
18K3.	1			SCHNEIDER	RXM4AB1P7	
18D1	1	DIOD MODUL 6	113 060	KLEMSAN	DM 6-S	
18H1	1	INDICATING LAMP GREEN	XB7-EV03BP	Telemecanique	XB7-EV03BP	
18H2	1	INDICATING LAMP WHITE	XB7-EV07BP	Telemecanique	XB7-EV07BP	
18S3	1	PUSH BUTTON	XB5-AC21	Telemecanique	XB5-AC21	
18S4	1	SELECTOR SWITCH	XB5-AK125B5	Telemecanique	XB5-AK125B5	
18K4	1			SCHNEIDER	RXM4AB1BD	
Q42	1			SCHNEIDER	NS2000N.	
Q43	1	CIRCUIT BREAKER NSX630N	NSX630N	Telemecanique	LV432876	
Q44	1	CIRCUIT BREAKER NSX400N	NSX400N	Telemecanique	LV432693	
Q45	1	CIRCUIT BREAKER NSX630N	NSX630N	Telemecanique	LV432876	
Q46	1	CIRCUIT BREAKER NSX630N	NSX630N	Telemecanique	LV432876	
Q47	1	CIRCUIT BREAKER NSX	TM2500	Telemecanique	LV431830	
Q48	1	CIRCUIT BREAKER NSX	TM2500	Telemecanique	LV431830	
Q49	1	CIRCUIT BREAKER NSX	TM2500	Telemecanique	LV431830	
Q50	1	CIRCUIT BREAKER NSX	TM2500	Telemecanique	LV431830	
Q51	1	CIRCUIT BREAKER NSX	TM2000	Telemecanique	LV431831	
Q52	1	CIRCUIT BREAKER NSX	TM2500	Telemecanique	LV431830	
Q53	1	CIRCUIT BREAKER NSX	TM2500	Telemecanique	LV431830	
Q54	1	CIRCUIT BREAKER NSX	TM2500	Telemecanique	LV431830	
Q55	1	CIRCUIT BREAKER NSX	TM2500	Telemecanique	LV431830	
Q56	1	CIRCUIT BREAKER NSX	TM2500	Telemecanique	LV431830	
Q57	1	CIRCUIT BREAKER NS	33466S2	Telemecanique	NS800N	
Q58	1	CIRCUIT BREAKER NS	33466S2	Telemecanique	NS800N	
Q59	1	CIRCUIT BREAKER NS	33466S2	Telemecanique	NS800N	
Q60	1	CIRCUIT BREAKER NS	33466S2	Telemecanique	NS800N	
Q61	1	CIRCUIT BREAKER NS	33472S2	Telemecanique	NS1000N.	
Q62	1	CIRCUIT BREAKER NS	33466S2	Telemecanique	NS800N	
Q2	1	POWER CIRCUIT BREAKER	NW12H1 3P ML2EW-2.0EH1	Telemecanique	NW12H1 3P ML2EW-2.0EH1	
24CT1	1			SEZGIN	1250/5A 10 VA	
24CT2	1			SEZGIN	1250/5A 10 VA	
24CT3	1			SEZGIN	1250/5A 10 VA	
24F1	1			SCHNEIDER	DF103	
24F1	3			SCHNEIDER	DF2CN10 10A	
24F6	1	SIGORTALI KLEMENS 6mm2 6.3A	351 109	KLEMSAN	ASK 2S	
24F7	1	SIGORTALI KLEMENS 6mm2 6.3A	351 109	KLEMSAN	ASK 2S	
24P1	1	METSEP	ENERGY ANALYZER	Telemecanique	METSEPM5340	
24P2	1			ISKRA	KILOWATTMETER -56/0-560KW	
24S2	1	VOLTMETER SELECTOR SWITCH	K1D024MLH	SCHNEIDER	K1D024MLH	
24P4	1	VOLTMETER	EC3V (96X96) DIRECT	ISKRA	VOLTMETER 0-500 V 96X96	
24F2	1	SIGORTALI KLEMENS 6mm2 6.3A	351 109	KLEMSAN	ASK 2S	

 HILAL GEMI MUHENDISLIK ELEKTRIK DONANIM VE OTOMASYON SAN. TIC. LTD. STI Gıptas San. Sitesi B/Blok No:30 İcmeleler/TUZLA Tel:0216 395 60 50 GSM:0539 648 88 05 www.hilalgemi.com	DATE		BESIKTAS SHIPYARD	YUZER HAVUZ 3	=	
	DRAWN BY					PROJE KOD
	CHECKED BY		CLASS	RINA	Highest Page Number	63

Bill of materials

Item	Amount	Designation	Type	Manufacturer	Article number	Note
24F3	1	SIGORTALI KLEMENS 6mm2 6.3A	351 109	KLEMSAN	ASK 2S	
24P5	1	FREQUENCYMETER	FC3A (96X96)	ISKRA	FREQ. METER 96-96 45-55HZ	
24TR1	1			AGPLUS	400/220V 500VA	
24S1	1	AMPERMETER SELECTOR SWITCH	K1F003MLH	SCHNEIDER	K1F003MLH	
24F4	1	SIGORTALI KLEMENS 6mm2 6.3A	351 109	KLEMSAN	ASK 2S	
24F5	1	SIGORTALI KLEMENS 6mm2 6.3A	351 109	KLEMSAN	ASK 2S	
24P3	1			ISKRA	AMMETER 0-1250/5A	
24S1	1			SCHNEIDER	XB5-AR31	
24S2	1	PUSH BUTTON	XB5-AR42	Telemecanique	XB5-AR42	
25K1	1			SCHNEIDER	RXM4AB1P7	
25K2	1			SCHNEIDER	RXM4AB1P7	
25K3	1			SCHNEIDER	RXM4AB1P7	
26S3	1	SELECTOR SWITCH	XB5-AK125B5	Telemecanique	XB5-AK125B5	
26K1	1			SCHNEIDER	RXM4AB1BD	
26K2	1			SCHNEIDER	RXM4AB1BD	
26S1	1	PUSH BUTTON	XB5-AC21	Telemecanique	XB5-AC21	
26D1	1	DIOD MODUL 6	113 060	KLEMSAN	DM 6-S	
26H1	1	INDICATING LAMP GREEN	XB7-EV03BP	Telemecanique	XB7-EV03BP	
26H2	1	INDICATING LAMP WHITE	XB7-EV07BP	Telemecanique	XB7-EV07BP	
26S2	1	SELECTOR SWITCH	XB5-AD21	Telemecanique	XB5-AD21	
26H4	1	INDICATING LAMP YELLOW	XB7-EV05BP	Telemecanique	XB7-EV05BP	
27H4	1	INDICATING LAMP WHITE	XB7-EV07BP	Telemecanique	XB7-EV07BP	
27S1	1	SELECTOR SWITCH	XB4-BD53	Telemecanique	XB4-BD53	
27K1	1			SCHNEIDER	RXM4AB1BD	
27K2	1			SCHNEIDER	RXM4AB1BD	
27S2	1	SELECTOR SWITCH	XB4-BD53	Telemecanique	XB4-BD53	
27K5	1			SCHNEIDER	RXM4AB1BD	
27K6	1			SCHNEIDER	RXM4AB1BD	
27K3	1			SCHNEIDER	RXM4AB1BD	
27K4	1			SCHNEIDER	RXM4AB1BD	
27S3	1	PUSH BUTTON RED	XB4-BA42	Telemecanique	XB4-BA42	
28F1	1			SCHNEIDER	DF103	
28F1	3			SCHNEIDER	DF2CN10 10A	
28S1	1	SELECTOR SWITCH	XB5-AD33	Telemecanique	XB5-AD33	
28K1	1			SCHNEIDER	CAD-32-V7	
28K2	1			SCHNEIDER	CAD-32-V7	
28K3	1			SCHNEIDER	CAD-32-V7	
28P1	1	Synchroscope	SC3VI-360	SACI	SYNC. SC3VI-360.	
28K4.	1			SCHNEIDER	CAD-32-V7	
28P2	1	DOUBLE VOLTMETER	2X400V EC3Vii (96X96)	SACI	DOUBLE VOLTMETER	
28P3	1	DOUBLE FREQUENCYMETER 46-54HZ	46-54HZ	SACI	DOUBLE FREQ46-54	
Q3	1	POWER CIRCUIT BREAKER	NW12H1 3P ML2EW-2.0EH1	Telemecanique	NW12H1 3P ML2EW-2.0EH1	
29CT1	1			SEZGIN	1250/5A 10 VA	
29CT2	1			SEZGIN	1250/5A 10 VA	
29CT3	1			SEZGIN	1250/5A 10 VA	
29F1	1			SCHNEIDER	DF103	
29F1	3			SCHNEIDER	DF2CN10 10A	
29F6	1	SIGORTALI KLEMENS 6mm2 6.3A	351 109	KLEMSAN	ASK 2S	
29F7	1	SIGORTALI KLEMENS 6mm2 6.3A	351 109	KLEMSAN	ASK 2S	
29P1	1	METSEP	ENERGY ANALYZER	Telemecanique	METSEPM5340	

Bill of materials

Item	Amount	Designation	Type	Manufacturer	Article number	Note
29P2	1				KILOWATTMETER 0-560KW	
29S2	1	VOLTMETER SELECTOR SWITCH	K1D024MLH	SCHNEIDER	K1D024MLH	
29P4	1	VOLTMETER	EC3V (96X96) DIRECT	ISKRA	VOLTMETER 0-500 V 96X96	
29F2	1	SIGORTALI KLEMENS 6mm2 6.3A	351 109	KLEMSAN	ASK 2S	
29F3	1	SIGORTALI KLEMENS 6mm2 6.3A	351 109	KLEMSAN	ASK 2S	
29P5	1	FREQUENCYMETER	FC3A (96X96)	ISKRA	FREQ. METER 96-96 45-55HZ	
29TR1	1			AGPLUS	400/220V 500VA	
29S1	1	AMPERMETER SELECTOR SWITCH	K1F003MLH	SCHNEIDER	K1F003MLH	
29F4	1	SIGORTALI KLEMENS 6mm2 6.3A	351 109	KLEMSAN	ASK 2S	
29F5	1	SIGORTALI KLEMENS 6mm2 6.3A	351 109	KLEMSAN	ASK 2S	
29P3	1			ISKRA	AMMETER 0-1250/5A	
30S1	1			SCHNEIDER	XB5-AR31	
30S2	1	PUSH BUTTON	XB5-AR42	Telemecanique	XB5-AR42	
30K1	1			SCHNEIDER	RXM4AB1P7	
30K2	1			SCHNEIDER	RXM4AB1P7	
30K3	1			SCHNEIDER	RXM4AB1P7	
31S1	1	SELECTOR SWITCH	XB5-AD21	Telemecanique	XB5-AD21	
31K1	1			SCHNEIDER	RXM4AB1BD	
31S2	1	PUSH BUTTON	XB5-AC21	Telemecanique	XB5-AC21	
31D1	1	DIOD MODUL 6	113 060	KLEMSAN	DM 6-S	
31H1	1	INDICATING LAMP GREEN	XB7-EV03BP	Telemecanique	XB7-EV03BP	
31H2	1	INDICATING LAMP WHITE	XB7-EV07BP	Telemecanique	XB7-EV07BP	
31H3	1	INDICATING LAMP YELLOW	XB7-EV05BP	Telemecanique	XB7-EV05BP	
31S3	1	SELECTOR SWITCH	XB5-AD21	Telemecanique	XB5-AD21	
31H4	1	INDICATING LAMP YELLOW	XB7-EV05BP	Telemecanique	XB7-EV05BP	
31H5	1	INDICATING LAMP WHITE	XB7-EV07BP	Telemecanique	XB7-EV07BP	
31F1	1	MINIATURE CIRCIUT BREAKER 10A	C60N 2P	SCHNEIDER	A9F74210	
31F3	1	SIGORTALI KLEMENS 6mm2 6.3A	351 109	KLEMSAN	ASK 2S	
31F4	1	SIGORTALI KLEMENS 6mm2 6.3A	351 109	KLEMSAN	ASK 2S	
31F5	1	SIGORTALI KLEMENS 6mm2 6.3A	351 109	KLEMSAN	ASK 2S	
31F6	1	SIGORTALI KLEMENS 6mm2 6.3A	351 109	KLEMSAN	ASK 2S	
31F2	1	MINIATURE CIRCIUT BREAKER 10A	C60N 2P	SCHNEIDER	A9F74210	
31F7	1	SIGORTALI KLEMENS 6mm2 6.3A	351 109	KLEMSAN	ASK 2S	
31F8	1	SIGORTALI KLEMENS 6mm2 6.3A	351 109	KLEMSAN	ASK 2S	
31F9	1	SIGORTALI KLEMENS 6mm2 6.3A	351 109	KLEMSAN	ASK 2S	
31F10	1	SIGORTALI KLEMENS 6mm2 6.3A	351 109	KLEMSAN	ASK 2S	
31F11	1	SIGORTALI KLEMENS 6mm2 6.3A	351 109	KLEMSAN	ASK 2S	
31F12	1	SIGORTALI KLEMENS 6mm2 6.3A	351 109	KLEMSAN	ASK 2S	
31F13	1	SIGORTALI KLEMENS 6mm2 6.3A	351 109	KLEMSAN	ASK 2S	
31F14	1	SIGORTALI KLEMENS 6mm2 6.3A	351 109	KLEMSAN	ASK 2S	
32S1	1	SELECTOR SWITCH	XB4-BD53	Telemecanique	XB4-BD53	
32K1	1			SCHNEIDER	RXM4AB1BD	
32K2	1			SCHNEIDER	RXM4AB1BD	
32S2	1	SELECTOR SWITCH	XB4-BD53	Telemecanique	XB4-BD53	
32K5	1			SCHNEIDER	RXM4AB1BD	
32K6	1			SCHNEIDER	RXM4AB1BD	
32K3	1			SCHNEIDER	RXM4AB1BD	
32K4	1			SCHNEIDER	RXM4AB1BD	
32S3	1	PUSH BUTTON RED	XB4-BA42	Telemecanique	XB4-BA42	
39K1	1				RPM21BD	

 <p>HILAL GEMI MUHENDISLIK ELEKTRIK DONANIM VE OTOMASYON SAN. TIC. LTD. STI Gıptas San. Sitesi B/Blok No:30 İçmeler/TUZLA Tel:0216 395 60 50 GSM:0539 648 88 05 www.hilalgemi.com</p>	DATE		BESIKTAS SHIPYARD	YUZER HAVUZ 3	=			
	DRAWN BY					PROJE KOD	BSK/HLL-YH32	Page Number
	CHECKED BY							

Bill of materials

Item	Amount	Designation	Type	Manufacturer	Article number	Note
39K2	1			SCHNEIDER	RPM21BD	
39K3	1			SCHNEIDER	RSB2A080BD	
39K4	1			SCHNEIDER	RSB2A080BD	
39K5	1			SCHNEIDER	RSB2A080BD	
39K6	1			SCHNEIDER	RSB2A080BD	
39K7	1			SCHNEIDER	RSB2A080BD	
39K8	1			SCHNEIDER	RPM21BD	
39K9	1			SCHNEIDER	RPM21BD	
39K10	1			SCHNEIDER	RSB2A080BD	
40K1	1			SCHNEIDER	RSB2A080BD	
40K2	1			SCHNEIDER	RSB2A080BD	
40K3	1			SCHNEIDER	RSB2A080BD	
40K4	1			SCHNEIDER	RSB2A080BD	
40K5	1			SCHNEIDER	RPM21BD	
40K6	1			SCHNEIDER	RPM21BD	
40K7	1			SCHNEIDER	RPM21BD	
40K8	1			SCHNEIDER	RPM21BD	
41K1	1			SCHNEIDER	RPM21BD	
41K2	1			SCHNEIDER	RPM21BD	
41K3	1			SCHNEIDER	RPM21BD	
41K4	1			SCHNEIDER	RPM21BD	
41K5	1			SCHNEIDER	RPM21BD	
41K6	1			SCHNEIDER	RPM21BD	
41K7	1			SCHNEIDER	RPM21BD	
41K8	1			SCHNEIDER	RPM21BD	
42K1	1			SCHNEIDER	RPM21BD	
42K2	1			SCHNEIDER	RPM21BD	
42K3	1			SCHNEIDER	RPM21BD	
42K4	1			SCHNEIDER	RPM21BD	
42K5	1			SCHNEIDER	RPM21BD	
42K6	1			SCHNEIDER	RPM21BD	
42K7	1			SCHNEIDER	RPM21BD	
42K8	1			SCHNEIDER	RPM21BD	
43K1	1			SCHNEIDER	RPM21BD	
43K2	1			SCHNEIDER	RPM21BD	
43K3	1			SCHNEIDER	RPM21BD	
43K4	1			SCHNEIDER	RPM21BD	
43K5	1			SCHNEIDER	RPM21BD	
43K6	1			SCHNEIDER	RPM21BD	
43K7	1			SCHNEIDER	RPM21BD	
43K8	1			SCHNEIDER	RPM21BD	
44K1	1			SCHNEIDER	RPM21BD	
44K2	1			SCHNEIDER	RPM21BD	
44K3	1			SCHNEIDER	RPM21BD	
44K4	1			SCHNEIDER	RPM21BD	
44K5	1			SCHNEIDER	RPM21BD	
44K6	1			SCHNEIDER	RPM21BD	
44K7	1			SCHNEIDER	RPM21BD	
44K8	1			SCHNEIDER	RPM21BD	
45K1	1			SCHNEIDER	RPM21BD	

 <p>HILAL GEMİ MUHENDİSLİK ELEKTRİK DONANIM VE OTOMASYON SAN. TİC. LTD. STİ Gıptas San. Sitesi B/Blok No:30 İçmeler/TUZLA Tel:0216 395 60 50 GSM:0539 648 88 05 www.hilalgemi.com</p>	DATE		BESIKTAS SHIPYARD	YUZER HAVUZ 3		=	
	DRAWN BY				PROJE KOD	BSK/HLL-YH32	Page Number 62
	CHECKED BY				CLASS	RINA	Highest Page Number 63

