

RXM4AB1P7		RXM4AB1P7	
11	12	11	12
.11	14 .5	.11	14 .6
21	22 .6	21	22
.21	24 .7	.21	24 .7
31	32 .6	31	32
.31	34 .6	.31	34
41	42 4.1	41	42
.41	44	.41	44

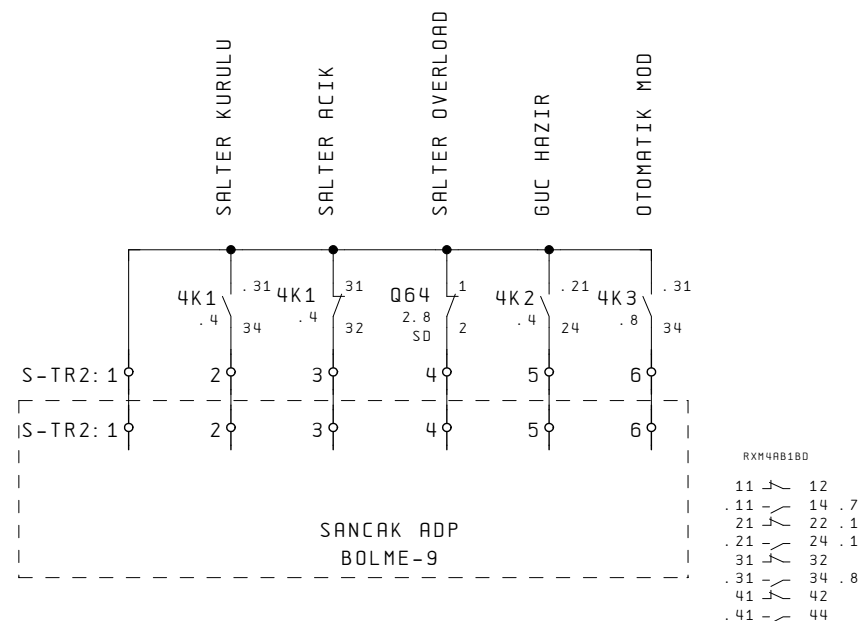

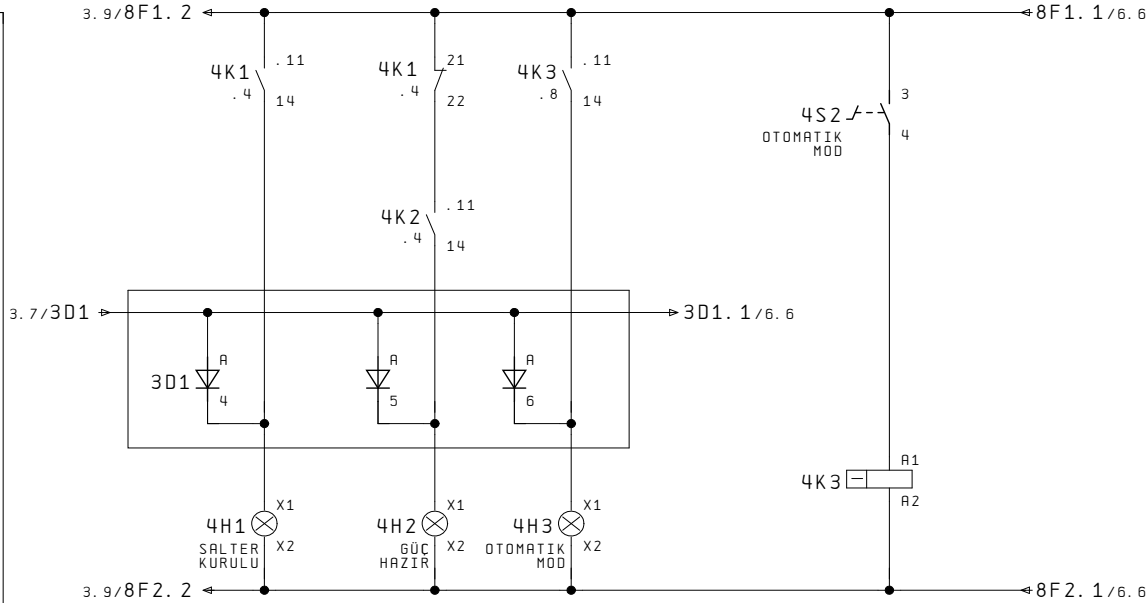
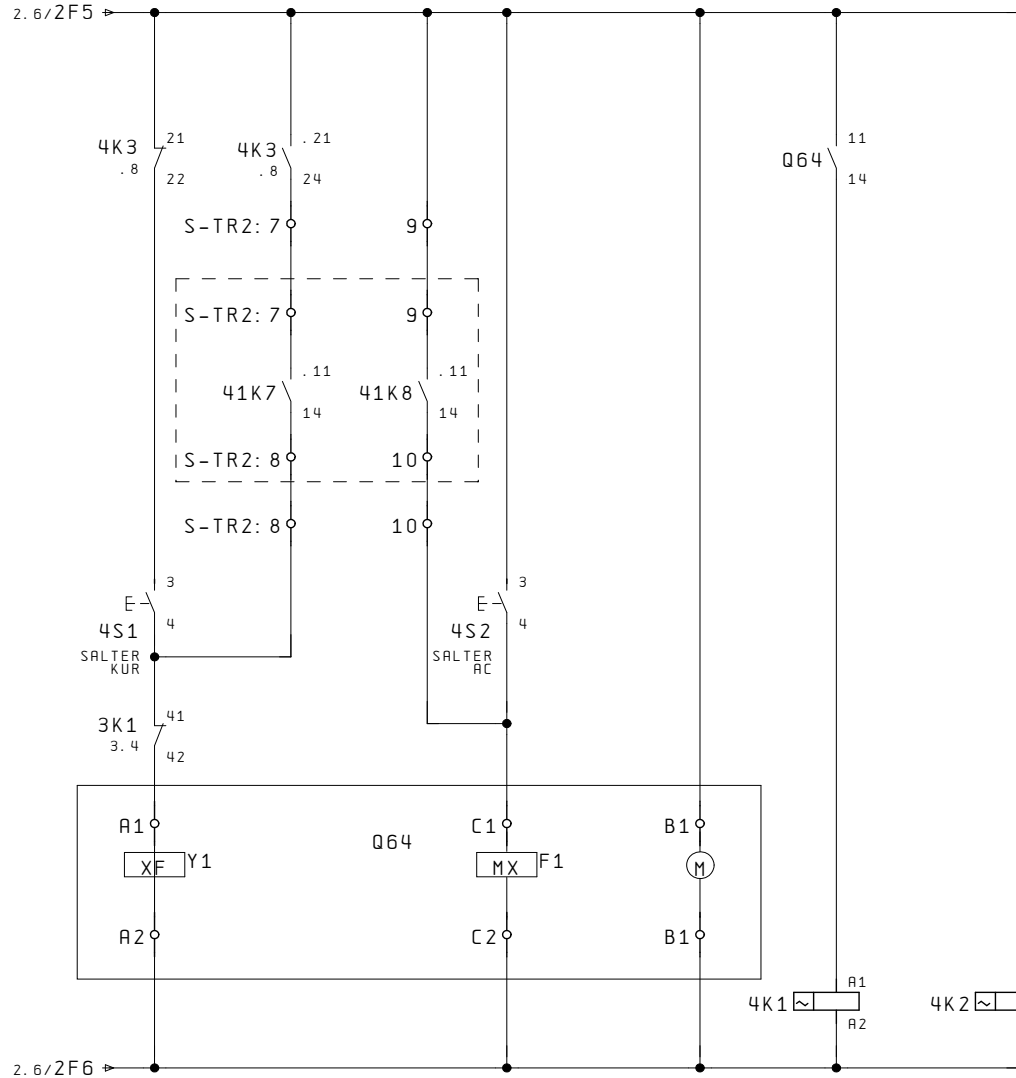

RXM4AB1P7		RXM4AB1P7	
11	12	11	12
.11	14 .5	.11	14 .6
21	22 .6	21	22
.21	24 .7	.21	24 .7
31	32 .6	31	32
.31	34 .6	.31	34
41	42 3.1	41	42
.41	44	.41	44

RXM4AB1B0	
11	12
.11	14 .7
21	22 .1
.21	24 .1
31	32
.31	34 .8
41	42
.41	44

3X100//10CU 440VAC 60HZ 3P

R/7.0
S/7.0
T/7.0

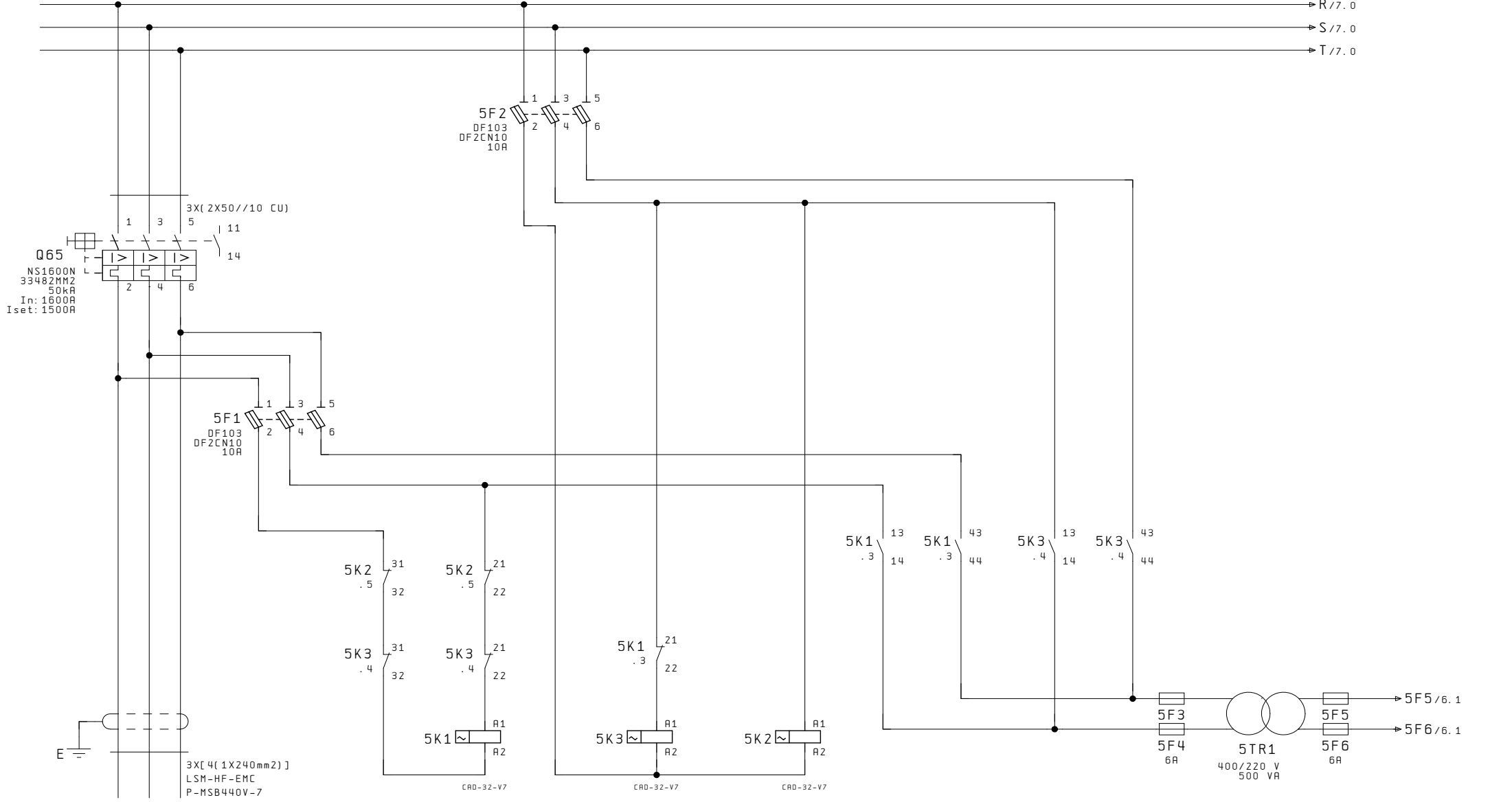

ISKELE 440VAC
TRANSFER
BOLME-9

13 - 14 .5	13 - 14 .6	13 - 14
43 - 44 .6	43 - 44 .7	43 - 44
03 - 04	03 - 04	03 - 04
21 - 22 .4	21 - 22 .3	21 - 22 .2 .3
31 - 32	31 - 32 .2	31 - 32 .2

 <p>HILAL GEMİ MUHENDİSLİK ELEKTRİK DONANIM VE OTOMASYON SAN. TİC. LTD. STİ Gıptas San. Sitesi B/Blok No:30 İcmeler/TUZLA Tel:0216 395 60 50 GSM:0539 648 88 05 www.hilalgemi.com</p>	DATE	SANCAK 440VAC PANEL ISKELE TRANSFER BOLME-10	BESIKTAS SHIPYARD	YUZER HAVUZ 3	=
	DRAWN BY	CHECKED BY	PROJE KOD	BSK/HLL-YH31	Page Number
			CLASS	RINA	Highest Page Number
					5
					13

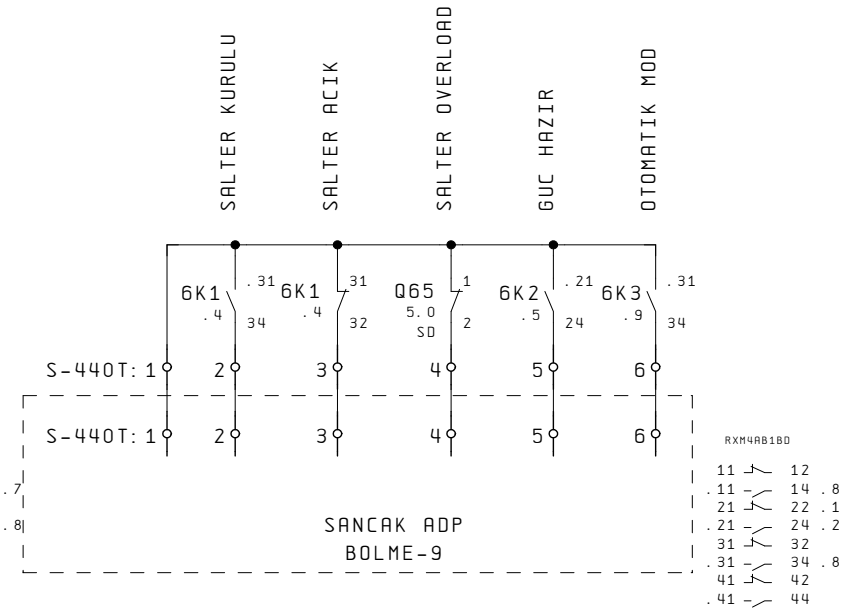
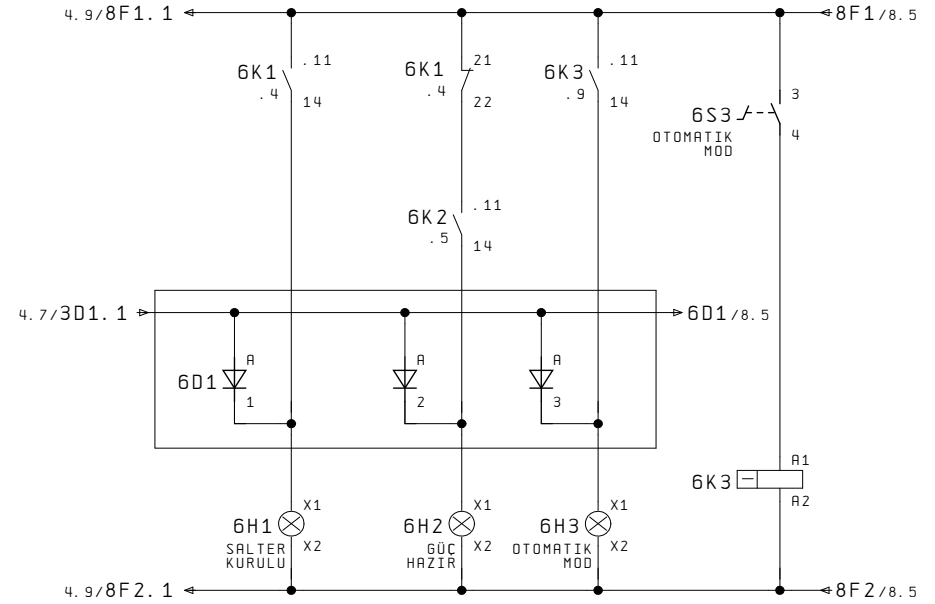
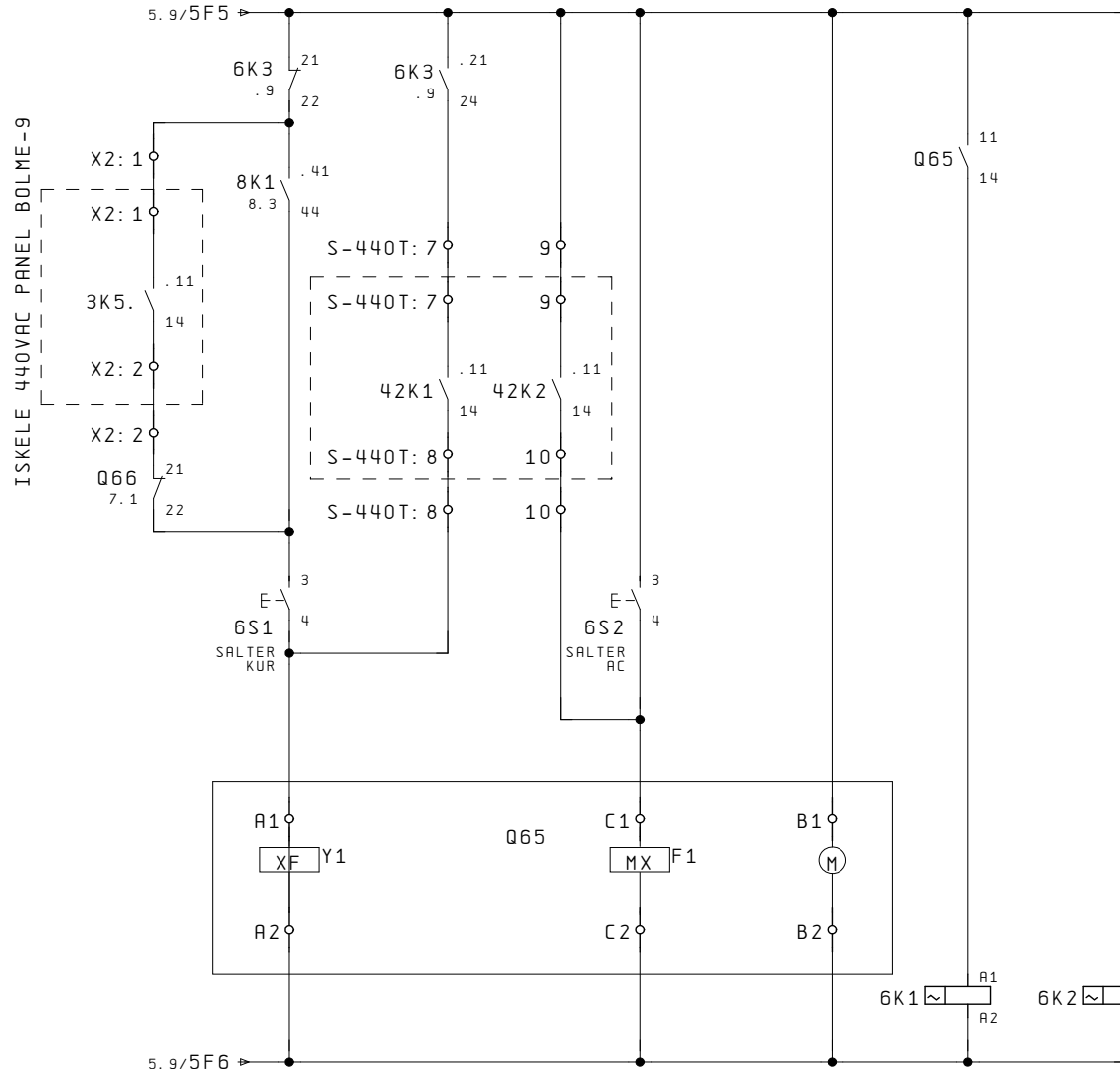

11	12	11	12
.11	14	.6	.11
21	22	.7	21
.21	24	.21	24
31	32	.7	31
.31	34	.6	.31
41	42	.41	42
.41	44	8.2	.41

11	12
.11	14
21	22
.21	24
31	32
.31	34
41	42
.41	44

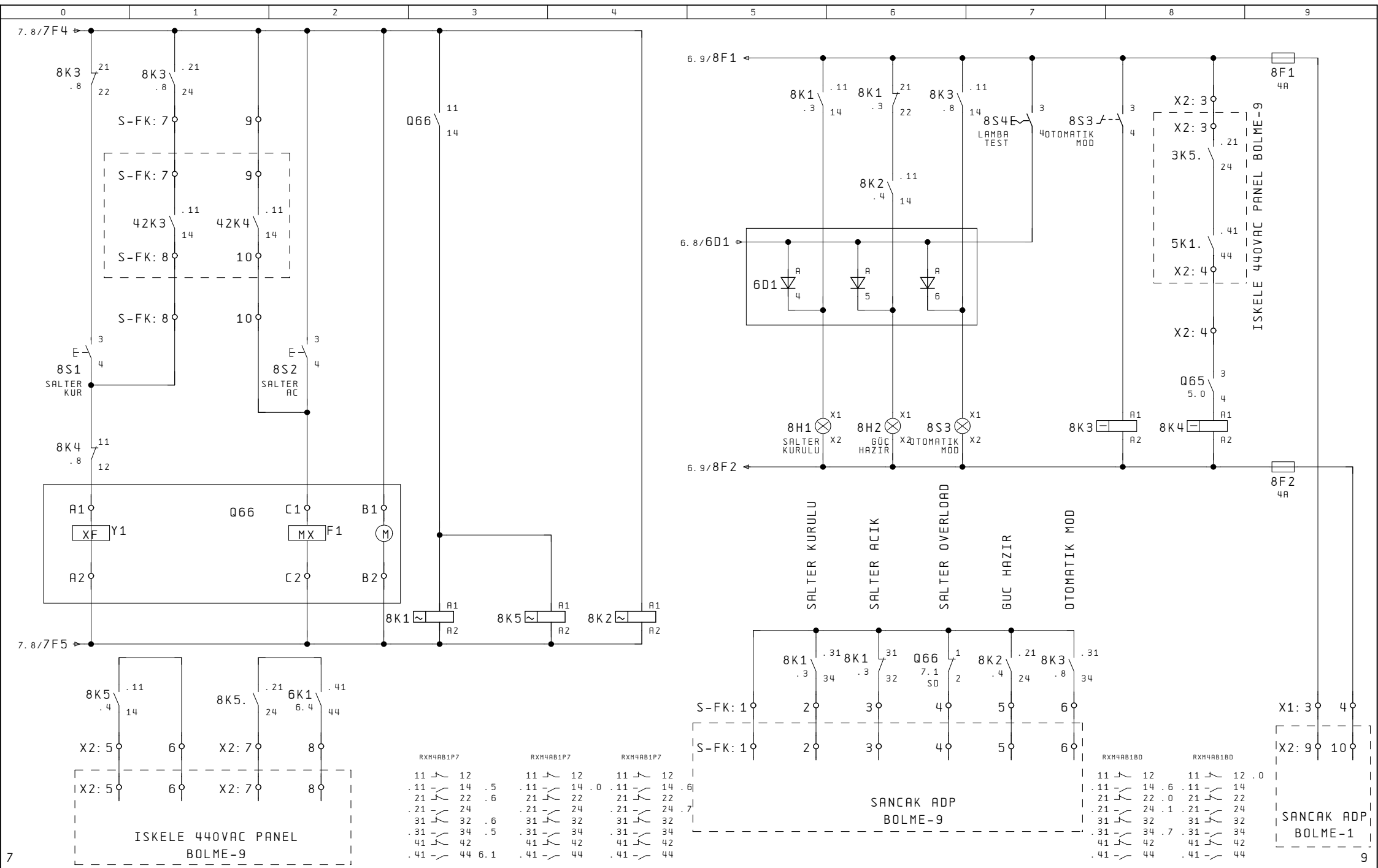

3X100//10CU

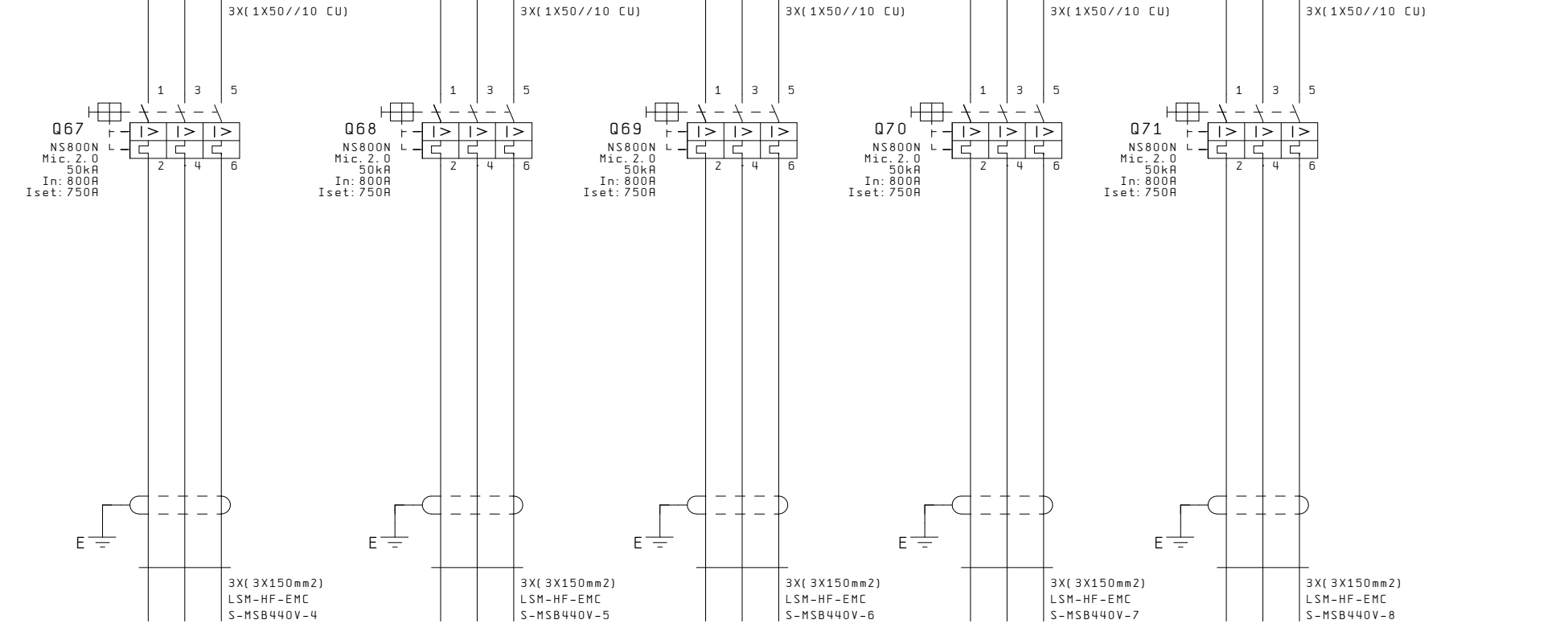
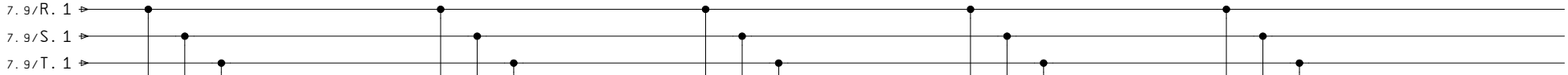

NO. 1 440VAC
DAGITIM PANELI

NO. 2 440VAC
DAGITIM PANELI

NO. 3 440VAC
DAGITIM PANELI

NO. 4 440VAC
DAGITIM PANELI

NO. 5 440VAC
DAGITIM PANELI

 <p>HILAL GEMİ MUHENDİSLİK ELEKTRİK DONANIM VE OTOMASYON SAN. TİC. LTD. STİ Gıptas San. Sitesi B/Blok No:30 İcmeler/TUZLA Tel:0216 395 60 50 GSM:0539 648 88 05 www.hilalgemi.com</p>	DATE	SANCAK 440VAC	BESIKTAS SHIPYARD	YUZER HAVUZ 3		=
	DRAWN BY	440VAC TUKETIM BOLME-11		PROJE KOD	BSK/HLL-YH31	Page Number
CHECKED BY			CLASS	RINA	Highest Page Number	9

SANCAK 440VAC PANEL
BOLME-10 TERMINAL

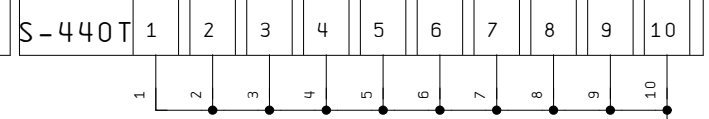
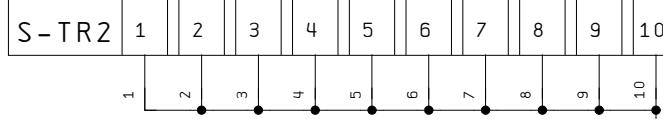
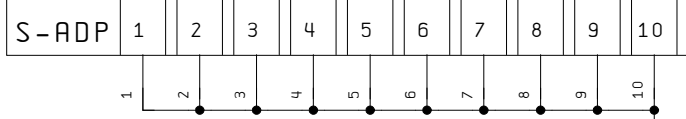

SANCAK ADP BOLME-9 S-ADP TERMINAL
10X1, 5mm2 LSM-HF-EMC P-MSB400V-86

SANCAK ADP BOLME-9 S-TR2 TERMINAL
10X1, 5mm2 LSM-HF-EMC P-MSB400V-87

SANCAK ADP BOLME-9 S-440T TERMINAL
10X1, 5mm2 LSM-HF-EMC P-MSB400V-88



DATE	
DRAWN BY	
CHECKED BY	

SANCAK 440VAC BAĞLANTI TERMINALI BOLME-10

BESIKTAS SHIPYARD

YUZER HAVUZ 3	
PROJE KOD	BSK/HLL-YH31
CLASS	RINA

=	
+	
Page Number	10
Highest Page Number	13

SANCAK 440VAC PANEL
BOLME-10 TERMINAL

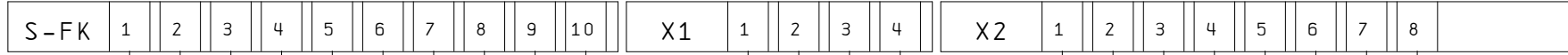

SANCAK ADP BOLME-9 S-FK TERMINAL
10X1, 5mm2 LSM-HF-EMC P-MSB400V-85

SANCAK ADP BOLME-1 X2 TERMINAL
4X1, 5mm2 LSM-HF-EMC P-MSB400V-84

ISKELE 440VAC PANEL BOLME-9
10X1, 5mm2 LSM-HF-EMC S-MSB440V-9



DATE		
DRAWN BY		
CHECKED BY		

SANCAK 440VAC BAĞLANTI TERMINALI BOLME-10

BESİKTAS SHIPYARD

YUZER HAVUZ 3	
PROJE KOD	BSK/HLL-YH31
CLASS	RINA

=		
+		
Page Number	11	
Highest Page Number	13	

Bill of materials

Item	Amount	Designation	Type	Manufacturer	Article number	Note
Q63	1	CIRCUIT BREAKER NS 33466MM2		Telemecanique	NS800N	
2F1	1			SCHNEIDER	DF103	
2F1	3			SCHNEIDER	DF2CN10 10A	
2TR1	1			AGP	400/220V 500VA	
2F2	1	SIGORTALI KLEMENS 6mm2 6.3A	351 109	KLEMSAN	ASK 2S	
2F3	1	SIGORTALI KLEMENS 6mm2 6.3A	351 109	KLEMSAN	ASK 2S	
2F5	1	SIGORTALI KLEMENS 6mm2 6.3A	351 109	KLEMSAN	ASK 2S	
2F6	1	SIGORTALI KLEMENS 6mm2 6.3A	351 109	KLEMSAN	ASK 2S	
2TR2	1			AGP	400/220V 500VA	
2F4	1			SCHNEIDER	DF103	
2F4	3			SCHNEIDER	DF2CN10 10A	
Q64	1	MAIN CIRCUIT BREAKER 1600A 33482MM2		Merlin Gerin	NS1600N	
3S1	1			SCHNEIDER	XB5-AR31	
3S2	1	PUSH BUTTON	XB5-AR42	Telemecanique	XB5-AR42	
3K1	1			SCHNEIDER	RXM4AB1P7	
3K2	1			SCHNEIDER	RXM4AB1P7	
3D1	1	DIOD MODUL 6	113 060	KLEMSAN	DM 6-S	
3H1	1	INDICATING LAMP GREEN	XB7-EV03BP	Telemecanique	XB7-EV03BP	
3H2	1	INDICATING LAMP WHITE	XB7-EV07BP	Telemecanique	XB7-EV07BP	
3H3	1	INDICATING LAMP YELLOW	XB7-EV05BP	Telemecanique	XB7-EV05BP	
3S3	1	SELECTOR SWITCH	XB5-AD21	Telemecanique	XB5-AD21	
3K3	1			SCHNEIDER	RXM4AB1BD	
4S1	1			SCHNEIDER	XB5-AR31	
4S2	1	PUSH BUTTON	XB5-AR42	Telemecanique	XB5-AR42	
4K1	1			SCHNEIDER	RXM4AB1P7	
4K2	1			SCHNEIDER	RXM4AB1P7	
4H1	1	INDICATING LAMP GREEN	XB7-EV03BP	Telemecanique	XB7-EV03BP	
4H2	1	INDICATING LAMP WHITE	XB7-EV07BP	Telemecanique	XB7-EV07BP	
4H3	1	INDICATING LAMP YELLOW	XB7-EV05BP	Telemecanique	XB7-EV05BP	
4S2	1	SELECTOR SWITCH	XB5-AD21	Telemecanique	XB5-AD21	
4K3	1			SCHNEIDER	RXM4AB1BD	
Q65	1	MAIN CIRCUIT BREAKER 1600A	33482S2W	Merlin Gerin	NS1600N	
5F1	1			SCHNEIDER	DF103	
5F1	3			SCHNEIDER	DF2CN10 10A	
5K1	1			SCHNEIDER	CAD-32-V7	
5F2	1			SCHNEIDER	DF103	
5F2	3			SCHNEIDER	DF2CN10 10A	
5K3	1			SCHNEIDER	CAD-32-V7	
5K2	1			SCHNEIDER	CAD-32-V7	
5F3	1	SIGORTALI KLEMENS 6mm2 6.3A	351 109	KLEMSAN	ASK 2S	
5F4	1	SIGORTALI KLEMENS 6mm2 6.3A	351 109	KLEMSAN	ASK 2S	
5TR1	1			AGP	400/220V 500VA	
5F5	1	SIGORTALI KLEMENS 6mm2 6.3A	351 109	KLEMSAN	ASK 2S	
5F6	1	SIGORTALI KLEMENS 6mm2 6.3A	351 109	KLEMSAN	ASK 2S	
6S1	1			SCHNEIDER	XB5-AR31	
6S2	1	PUSH BUTTON	XB5-AR42	Telemecanique	XB5-AR42	
6K1	1			SCHNEIDER	RXM4AB1P7	
6K2	1			SCHNEIDER	RXM4AB1P7	
6D1	1	DIOD MODUL 6	113 060	KLEMSAN	DM 6-S	
6H1	1	INDICATING LAMP GREEN	XB7-EV03BP	Telemecanique	XB7-EV03BP	

