

PANO YAN GÖRÜNÜŞ

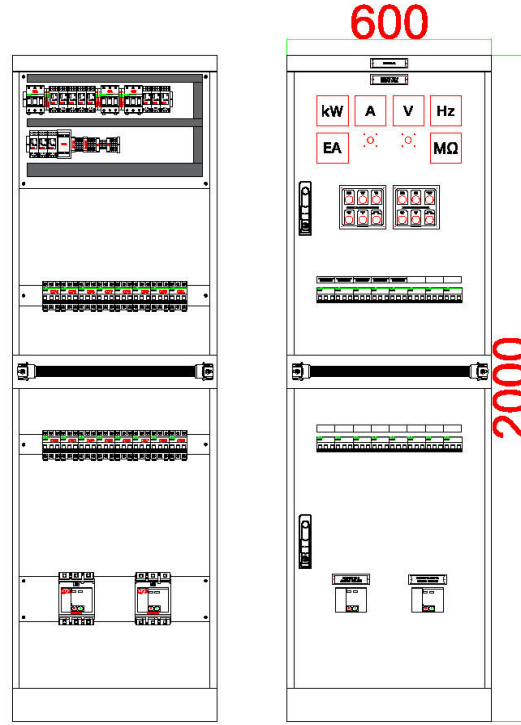

PANO İÇ VE ÖN GÖRÜNÜŞ

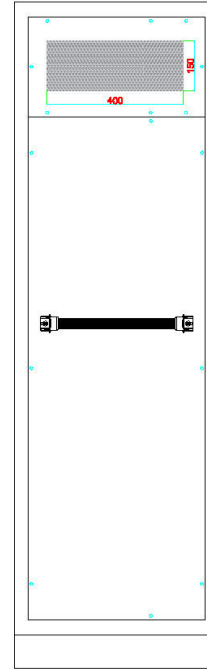

PANO ARKA GÖRÜNÜŞ

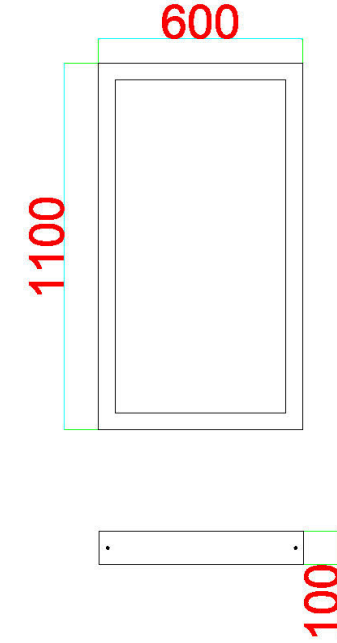

PANO FOUNDATION GÖRÜNÜŞ

 HILAL GEMİ MUHENDİSLİK ELEKTRİK DONANIM VE OTOMASYON SAN. TİC. LTD. STİ Gıptas San. Sitesi B/Blok No:30 İcmeler/TUZLA Tel:0216 395 60 50 GSM:0539 648 88 05 www.hilalgemi.com	DATE	SANCAK 220VAC PANEL GENERAL VIEW	BESIKTAS SHIPYARD	YUZER HAVUZ 3	=
	DRAWN BY			PROJE KOD	BSK/HLL-YH34
CHECKED BY			CLASS	RINA	Highest Page Number

220VAC 50HZ

3X(30//10) CU

R/4.0

S/4.0

T/4.0

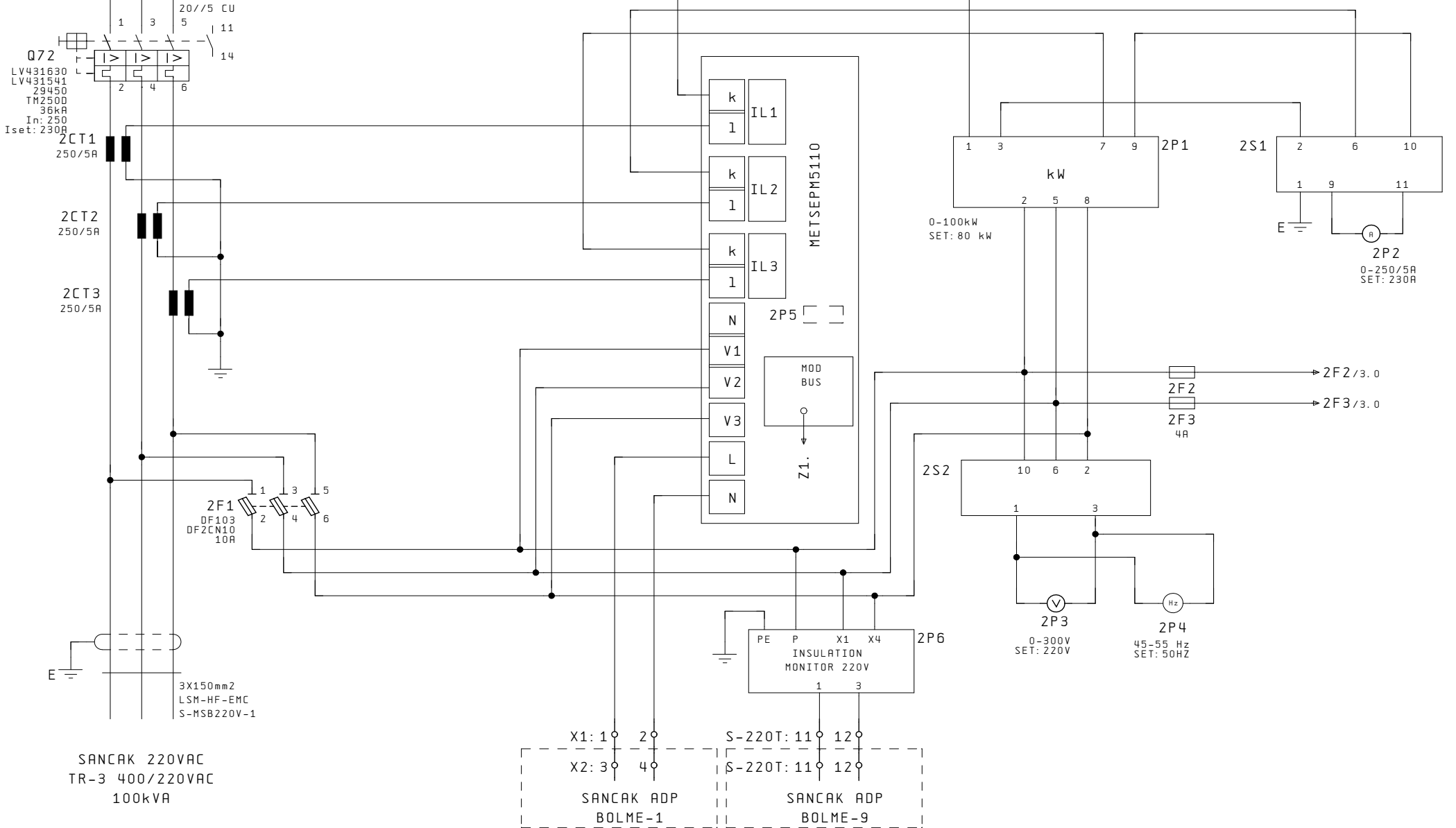

SANCAK 220VAC
TR-3 400/220VAC
100kVA

3X150mm2
LSM-HF-EMC
S-MSB220V-1

X1: 1 2
X2: 3 4
SANCAK ADP
BOLME-1

S-220T: 11 12
S-220T: 11 12
SANCAK ADP
BOLME-9

3



HILAL GEMİ MUHENDİSLİK
ELEKTRİK DONANIM VE OTOMASYON SAN. TİC. LTD. STİ
Gıptas San. Sitesi B/Blok No:30 İcmeler/TUZLA
Tel:0216 395 60 50 GSM:0539 648 88 05
www.hilalgemi.com

DATE
DRAWN BY
CHECKED BY

SANCAK 220VAC PANEL
BOLME-12
TR-3 BESLEME

BESIKTAS SHIPYARD

YUZER HAVUZ 3

PROJE KOD
CLASS

BSK/HLL-YH34
RINA

Page Number
Highest Page Number

2

11

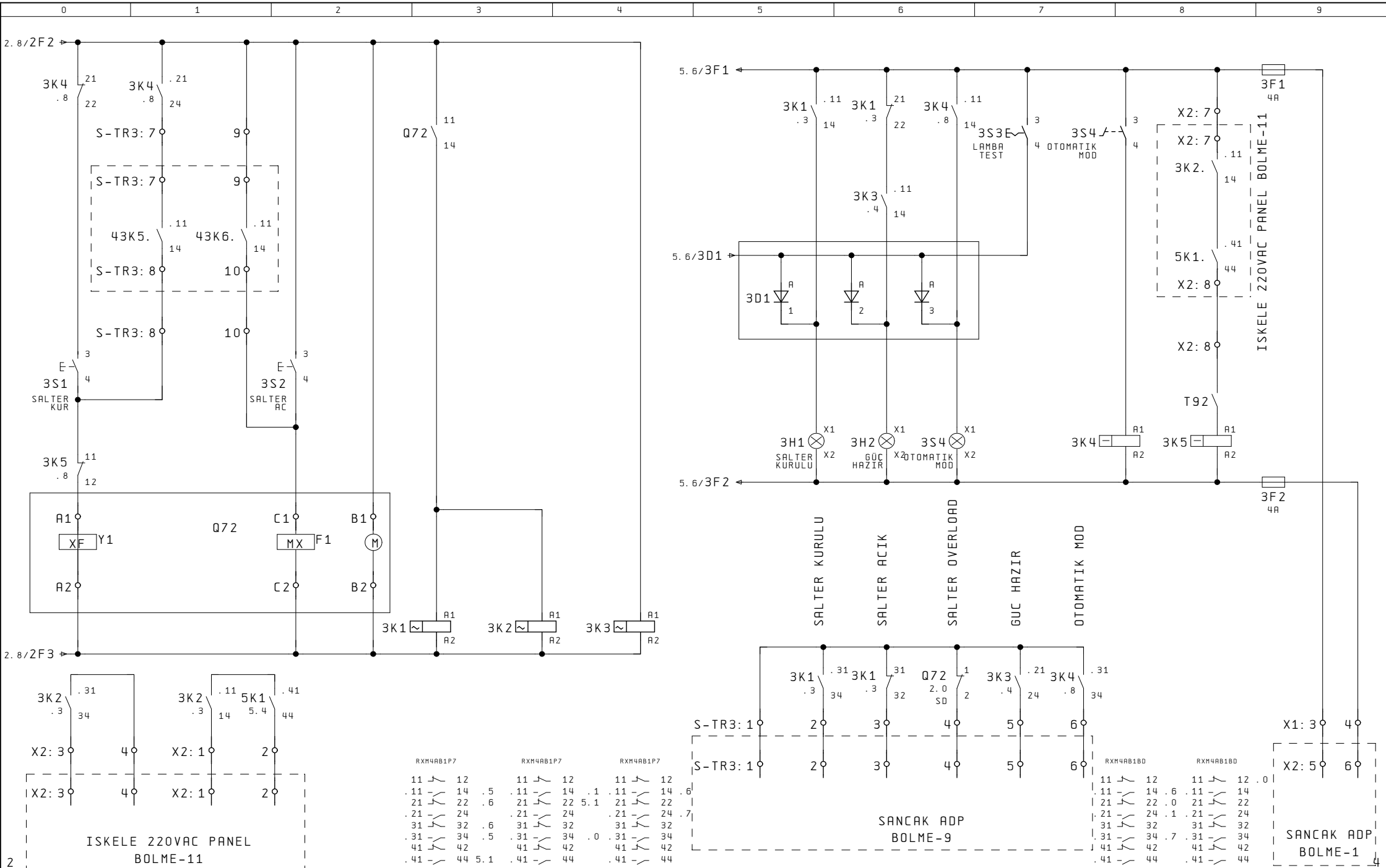

2. 9/R → R. 1/6. 0
 2. 9/S → S. 1/6. 0
 2. 9/T → T. 1/6. 0

220VAC 50HZ

3X(30//10) CU

Q73
 LV431830
 LV431541
 29450
 TH250D
 50kA
 In: 250
 Iset: 230A

20//5 CU

4F2
 DF103
 DF2CN10
 10A

4F1
 DF103
 DF2CN10
 10A

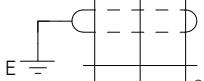

3X150mm2
 LSM-HF-EMC
 P-MSB220V-7

ISKELE 220VAC
 TRANSFER
 100kVA

RXM4AB1P7

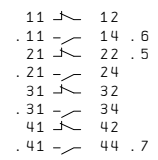

RXM4AB1P7

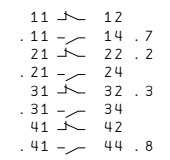

RXM4AB1P7

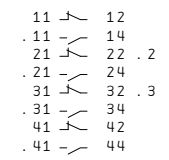

4K1
 .3

4K1
 .3

4K3
 .5

4K3
 .5

4F3
 4F4
 6A

<p>HILAL GEMİ MUHENDİSLİK ELEKTRİK DONANIM VE OTOMASYON SAN. TİC. LTD. STİ Gıptas San. Sitesi B/Blok No:30 İcmeler/TUZLA Tel:0216 395 60 50 GSM:0539 648 88 05 www.hilalgemi.com</p>	DATE	SANCAK 220VAC PANEL BOLME-12 ISKELE TRANSFER	BESIKTAS SHIPYARD	YUZER HAVUZ 3	=
	DRAWN BY	CHECKED BY	PROJE KOD	BSK/HLL-YH34	Page Number
			CLASS	RINA	Highest Page Number

ISKEL 220VAC PANEL BOLME-11

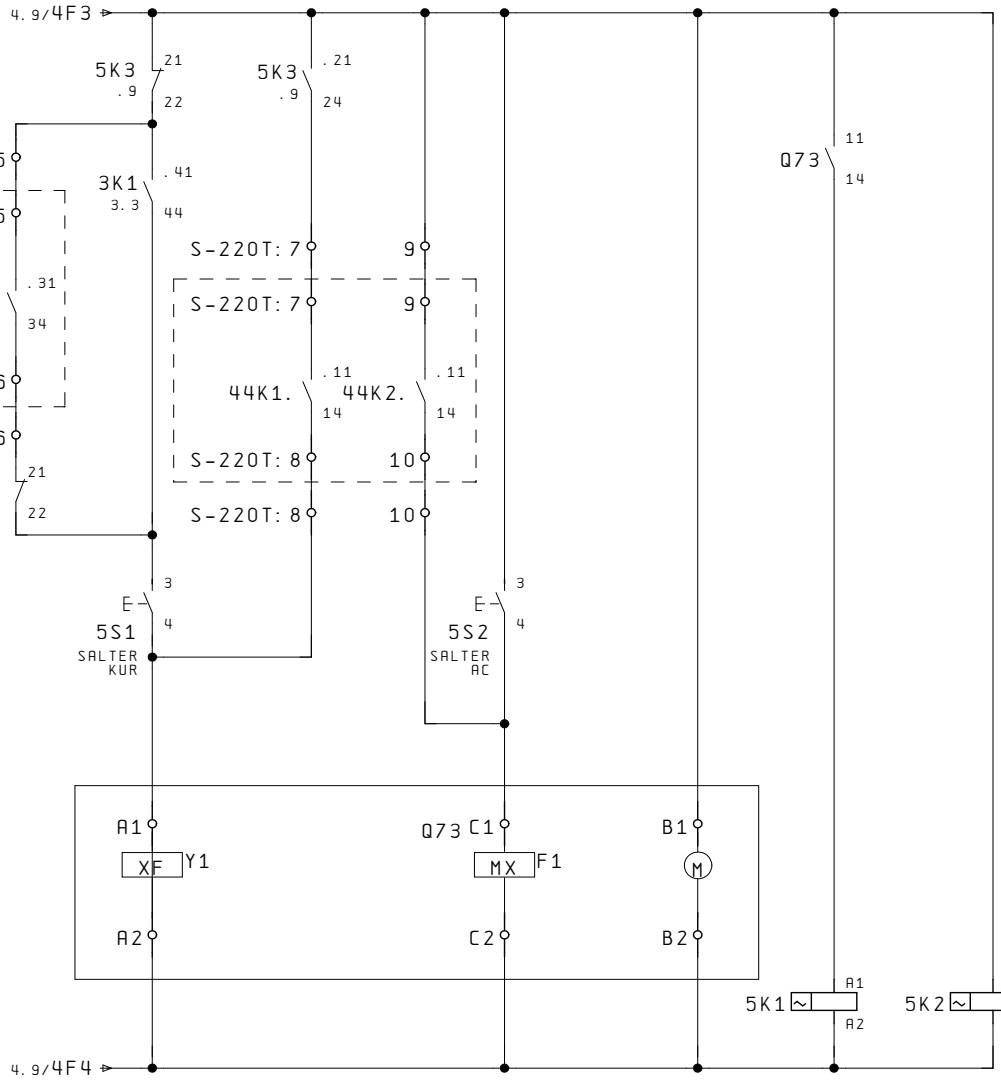

RXM4AB1P7		RXM4AB1P7	
11	12	11	12
.11	.14	.11	.14
21	22	21	22
.21	.24	.21	.24
31	32	31	32
.31	.34	.31	.34
41	42	41	42
.41	.44	.41	.44

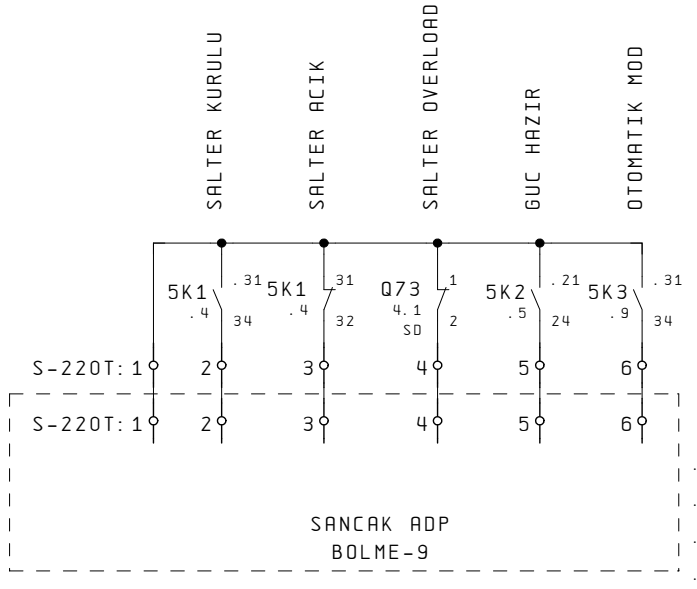
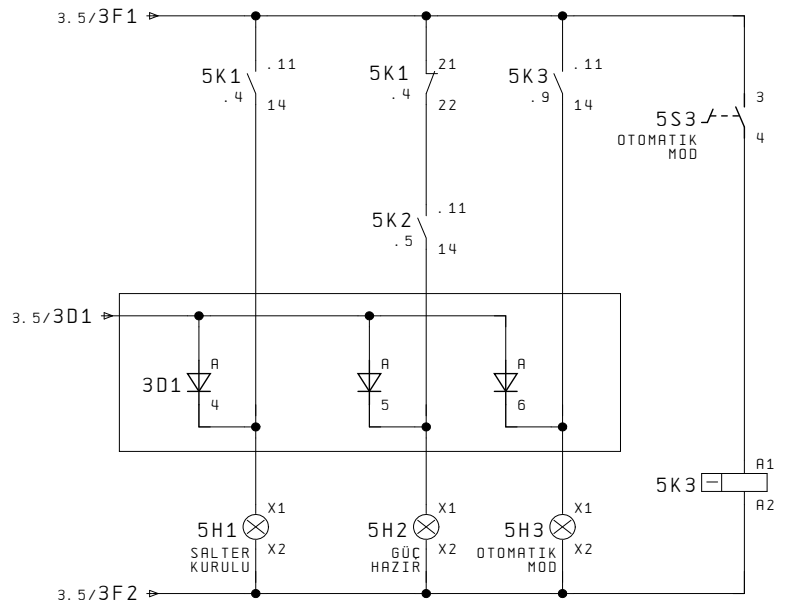

RXM4AB1B0	
11	12
.11	.14
21	22
.21	.24
31	32
.31	.34
41	42
.41	.44

4

6



HILAL GEMİ MUHENDİSLİK
ELEKTRİK DONANIM VE OTOMASYON SAN. TİC. LTD. STİ
Gıptas San. Sitesi B/Blok No:30 İçmeler/TUZLA
Tel:0216 395 60 50 GSM:0539 648 88 05
www.hilalgemi.com

DATE
DRAWN BY
CHECKED BY

SANCAP 220VAC PANEL
BOLME-12
ISKELE TRANSFER

BESIKTAS SHIPYARD

YUZER HAVUZ 3
PROJE KOD
CLASS

BSK/HLL-YH34
RINA
Page Number
Highest Page Number

5

11

3X30//10CU

4. 9/R. 1 → R. 2/7. 0
 4. 9/S. 1 → S. 2/7. 0
 4. 9/T. 1 → T. 2/7. 0

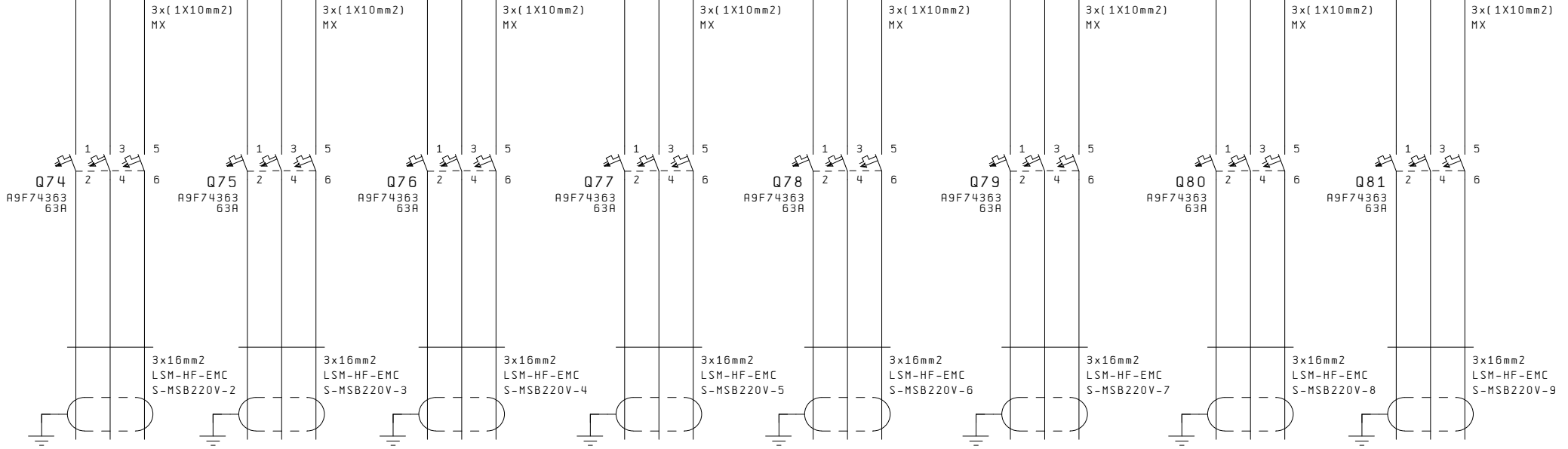

NO. 1 AYDINLATMA
VE DAGITIM PANELI

NO. 2 AYDINLATMA
VE DAGITIM PANELI

NO. 3 AYDINLATMA
VE DAGITIM PANELI

NO. 4 AYDINLATMA
VE DAGITIM PANELI

NO. 5 AYDINLATMA
VE DAGITIM PANELI

YEDEK

YEDEK

YEDEK

5

7



HILAL GEMİ MUHENDİSLİK
ELEKTRİK DONANIM VE OTOMASYON SAN. TİC. LTD. STİ
Gıptas San. Sitesi B/Blok No:30 İcmeler/TUZLA
Tel:0216 395 60 50 GSM:0539 648 88 05
www.hilalgemi.com

DATE
DRAWN BY
CHECKED BY

SANCAK 220VAC PANEL
BOLME-12
220VAC TÜKETİM

BESİKTAS SHİPYARD

YUZER HAVUZ 3

PROJE KOD
CLASS

BSK/HLL-YH34
RINA

Page Number
Highest Page Number

6

11

3X30//10CU

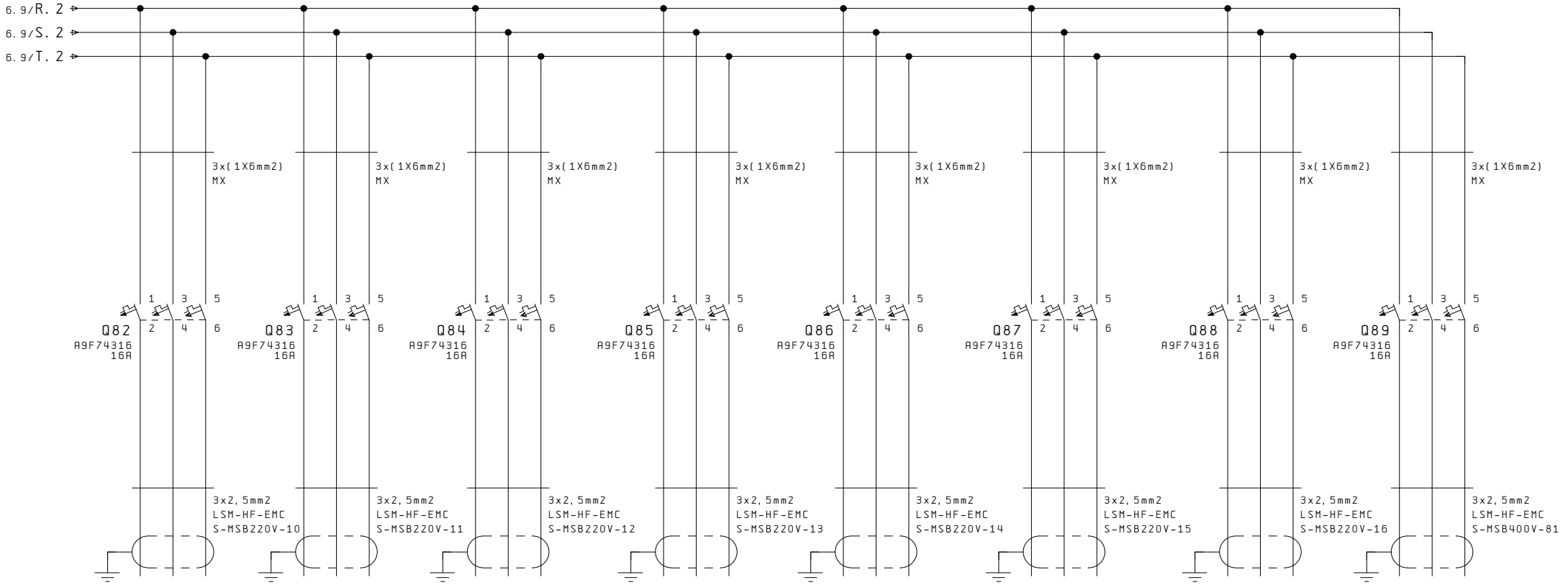

YEDEK

YEDEK

YEDEK

YEDEK

YEDEK

YEDEK

YEDEK

JENERATOR CEKET
ISITICI BESLEME



HILAL GEMİ MUHENDİSLİK
ELEKTRİK DONANIM VE OTOMASYON SAN. TİC. LTD. STİ
Gıptas San. Sitesi B/Blok No:30 İcmeler/TUZLA
Tel:0216 395 60 50 GSM:0539 648 88 05
www.hilalgemi.com

DATE	
DRAWN BY	
CHECKED BY	

SANCAK 220VAC PANEL
BOLME-12
220VAC TÜKETİM

BESIKTAS SHIPYARD

YUZER HAVUZ 3

PROJE KOD	BSK/HLL-YH34	Page Number	7
CLASS	RINA	Highest Page Number	11

SANCAK 220VAC PANEL

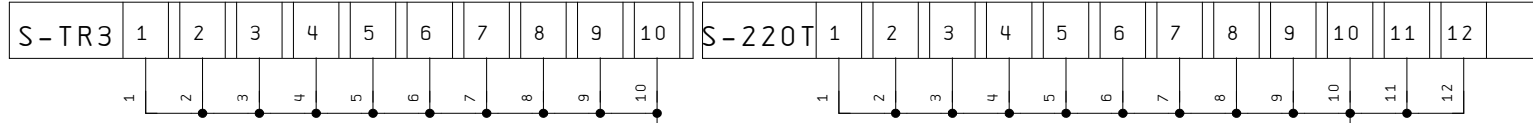

SANCAK ADP BOLME-9 P-TR3 TERMINAL
10X1, 5mm2 LSM-HF-EMC S-MSB400V-93

SANCAK ADP BOLME-9 P-220T TERMINAL
19X1, 5mm2 LSM-HF-EMC S-MSB400V-94

 <p>HILAL GEMİ MUHENDİSLİK ELEKTRİK DONANIM VE OTOMASYON SAN. TİC. LTD. STİ Gıptas San. Sitesi B/Blok No:30 İcmeler/TUZLA Tel:0216 395 60 50 GSM:0539 648 88 05 www.hilalgemi.com</p>	DATE		BESIKTAS SHIPYARD	YUZER HAVUZ 3		=	
	DRAWN BY			PROJE KOD	BSK/HLL-YH34	Page Number	8
	CHECKED BY				CLASS	RINA	Highest Page Number

SANCAK 220VAC
BOLME-12

X1 1 2 3 4

1 2 3 4

SANCAK ADP BOLME-1 X2 TERMINAL

4X1, 5mm² LSM-HF-EMC P-MSB400V-82

SANCAK 220VAC
BOLME-12

X2 1 2 3 4 5 6 7 8

1 2 3 4 5 6 7 8

YSKELE 220VAC PANEL BOLME-11 X2 TERMINAL

10X1, 5mm² LSM-HF-EMC S-MSB220V-17



Bill of materials

Item	Amount	Designation	Type	Manufacturer	Article number	Note
Q72	1	CIRCUIT BREAKER NSX	TM2500	Telemecanique	LV431830	
Q72	1	MT250	MOTOR 220VAC	Telemecanique	LV431541	
Q72	3	AUXLARY CONTACT	NSX100-630 CONTACT	Telemecanique	29450	
2CT1	1	CURRENT TRANSFORMER	250/5A 10 VA	SEZGIN	250/5A 10 VA	
2CT2	1	CURRENT TRANSFORMER	250/5A 10 VA	SEZGIN	250/5A 10 VA	
2CT3	1	CURRENT TRANSFORMER	250/5A 10 VA	SEZGIN	250/5A 10 VA	
2F1	1			SCHNEIDER	DF103	
2F1	3			SCHNEIDER	DF2CN10 10A	
2P6	1			DEIF	INS.MON. IAC3VA 220V W/C	
2P5	1	METSEP	ENERGY ANALYZER	Telemecanique	METSEPM5110	
2P1	1			ISKRA	KILOWATTMETER 0-100KW	
2S2	1	VOLTMETER SELECTOR SWITCH	K1D024MLH	SCHNEIDER	K1D024MLH	
2P3	1	VOLTMETER	EC3V (96X96) DIRECT	ISKRA	VOLTMETER 0-500 V 96X96	
2P4	1	FREQUENCYMETER	FC3A (96X96)	ISKRA	FREQ. METER 96-96 45-55HZ	
2F2	1	SIGORTALI KLEMENS 6mm2 6.3A	351 109	KLEMSAN	ASK 2S	
2F3	1	SIGORTALI KLEMENS 6mm2 6.3A	351 109	KLEMSAN	ASK 2S	
2S1	1	AMPERMETER SELECTOR SWITCH	K1F003MLH	SCHNEIDER	K1F003MLH	
2P2	1	AMMETER	EC3V (96X96)	ISKRA	AMMETER 0-1200/5A	
X2:3	32	RAY KLEMENS 2.5mm2	304 120	KLEMSAN	AVK 2.5	
3S1	1			SCHNEIDER	XB5-AR31	
3S2	1	PUSH BUTTON	XB5-AR42	Telemecanique	XB5-AR42	
3K1	1			SCHNEIDER	RXM4AB1P7	
3K2	1			SCHNEIDER	RXM4AB1P7	
3K3	1			SCHNEIDER	RXM4AB1P7	
3D1	1	DIOD MODUL 6	113 060	KLEMSAN	DM 6-S	
3H1	1	INDICATING LAMP GREEN	XB7-EV03BP	Telemecanique	XB7-EV03BP	
3H2	1	INDICATING LAMP WHITE	XB7-EV07BP	Telemecanique	XB7-EV07BP	
3S3	1	PUSH BUTTON	XB5-AC21	Telemecanique	XB5-AC21	
3S4	1	SELECTOR SWITCH	XB5-AK125B5	Telemecanique	XB5-AK125B5	
3K4	1			SCHNEIDER	RXM4AB1BD	
3K5	1			SCHNEIDER	RXM4AB1BD	
3F1	1	SIGORTALI KLEMENS 6mm2 6.3A	351 109	KLEMSAN	ASK 2S	
3F2	1	SIGORTALI KLEMENS 6mm2 6.3A	351 109	KLEMSAN	ASK 2S	
Q73	1	CIRCUIT BREAKER NSX	TM2500	Telemecanique	LV431830	
Q73	1	MT250	MOTOR 220VAC	Telemecanique	LV431541	
Q73	3	AUXLARY CONTACT	NSX100-630 CONTACT	Telemecanique	29450	
4F1	1			SCHNEIDER	DF103	
4F1	3			SCHNEIDER	DF2CN10 10A	
4K1	1			SCHNEIDER	RXM4AB1P7	
4F2	1			SCHNEIDER	DF103	
4F2	3			SCHNEIDER	DF2CN10 10A	
4K3	1			SCHNEIDER	RXM4AB1P7	
4K2	1			SCHNEIDER	RXM4AB1P7	
4F3	1	SIGORTALI KLEMENS 6mm2 6.3A	351 109	KLEMSAN	ASK 2S	
4F4	1	SIGORTALI KLEMENS 6mm2 6.3A	351 109	KLEMSAN	ASK 2S	
5S1	1			SCHNEIDER	XB5-AR31	
5S2	1	PUSH BUTTON	XB5-AR42	Telemecanique	XB5-AR42	
5K1	1			SCHNEIDER	RXM4AB1P7	
5K2	1			SCHNEIDER	RXM4AB1P7	
5H1	1	INDICATING LAMP GREEN	XB7-EV03BP	Telemecanique	XB7-EV03BP	

