

SANCAK 220V
ANA DAGITIM PANOSU

PONTOON 5
KOMBINE PRIZ KUTUSU

PONTOON 5
KOMBINE PRIZ KUTUSU

PONTOON 5
KOMBINE PRIZ KUTUSU

NO 3 HAVUZ BORDA
PRIZ PANOSU

SANCAK 400V ADP
220VAC BESLEME BOLME-1

PONTOON 5
AYDINLATMA DEVRESI

YEDEK

HAVUZ ICI PROJektor
PONTOON 5 FR-198

HAVUZ UST AYDINLATMA
PONTOON 5



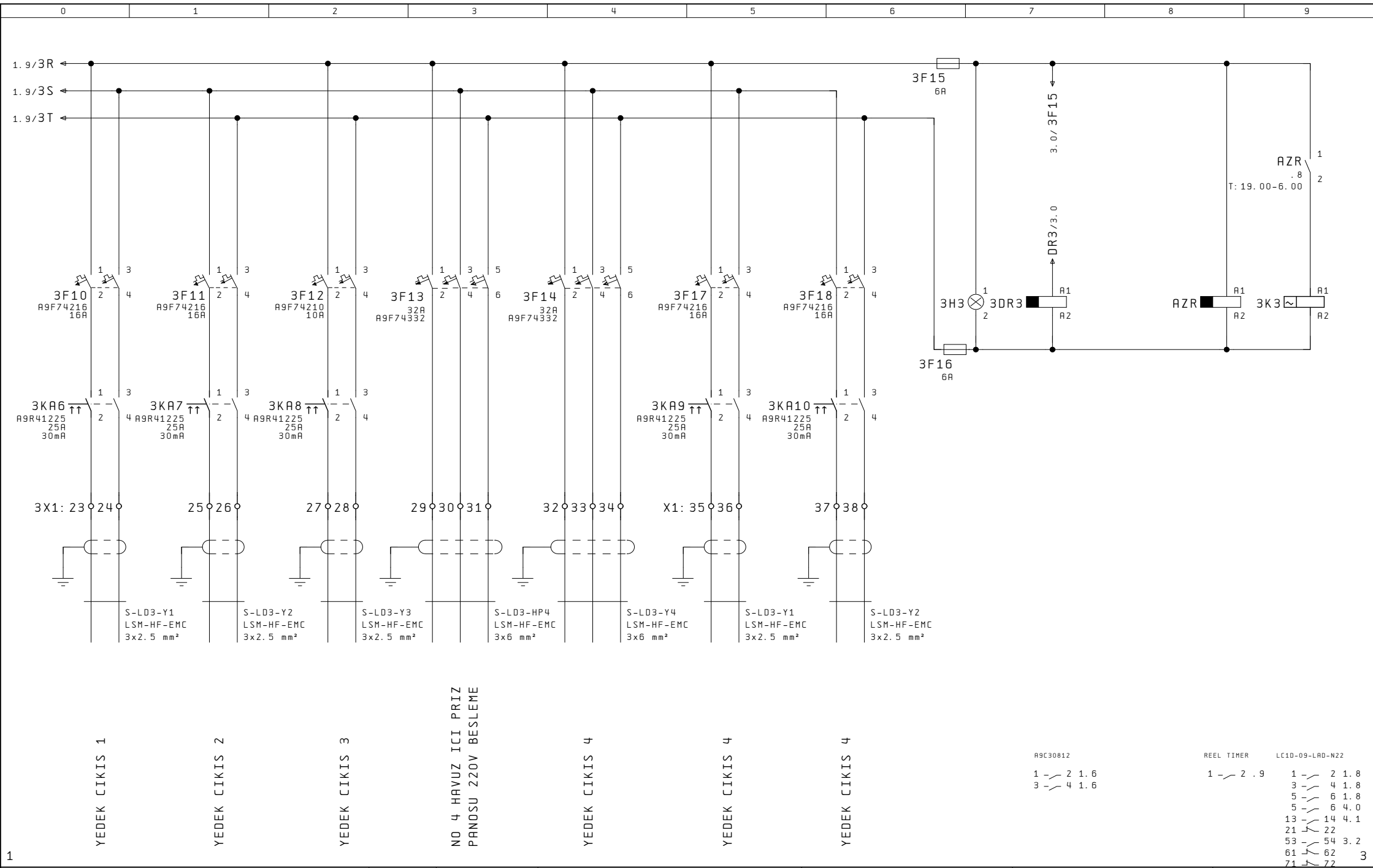

A9C30812	REEL TIMER	LC10-09-LAD-N22
1 - 2 1.6	1 - 2 .9	1 - 2 1.8
3 - 4 1.6		3 - 4 1.8
		5 - 6 1.8
		5 - 6 4.0
		13 - 14 4.1
		21 - 22
		53 - 54 3.2
		61 - 62
		71 - 72
		83 - 84 3.2

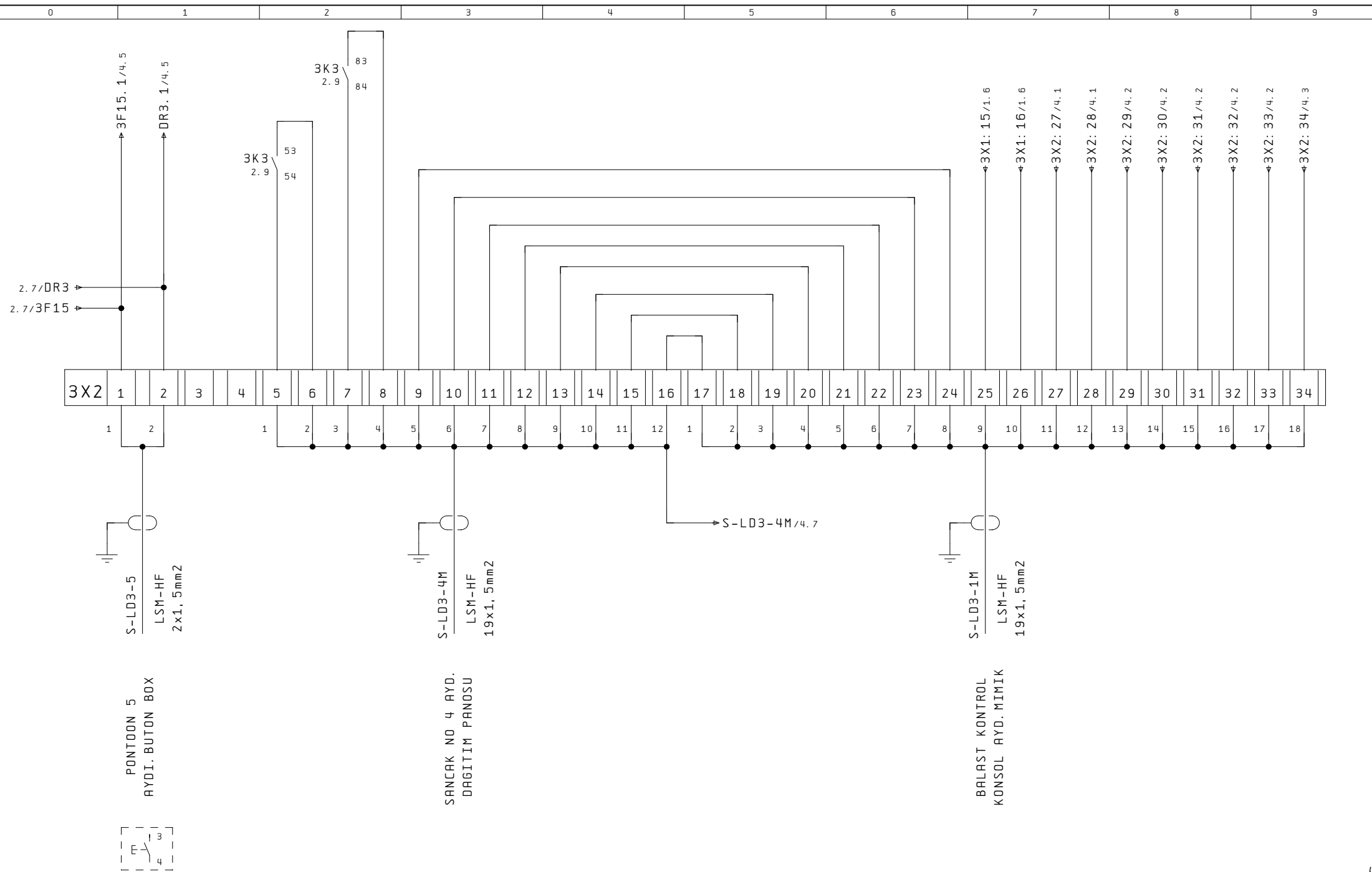

 HILAL GEMİ MUHENDİSLİK ELEKTRİK DONANIM VE OTOMASYON SAN. TİC. LTD. STİ Gıptas San. Sitesi B/Blok No:30 İçmeler/TUZLA Tel:0216 395 60 50 GSM:0539 648 88 05 www.hilalgemi.com	DATE	SANCAK MAIN AYDINLATMA PANOSU LD3	BESIKTAS SHIPYARD	YUZER HAVUZ 3		=
	DRAWN BY			PROJE KOD	BSK/HLL-YH04	Page Number
CHECKED BY	CLASS	RINA	Highest Page Number	35		

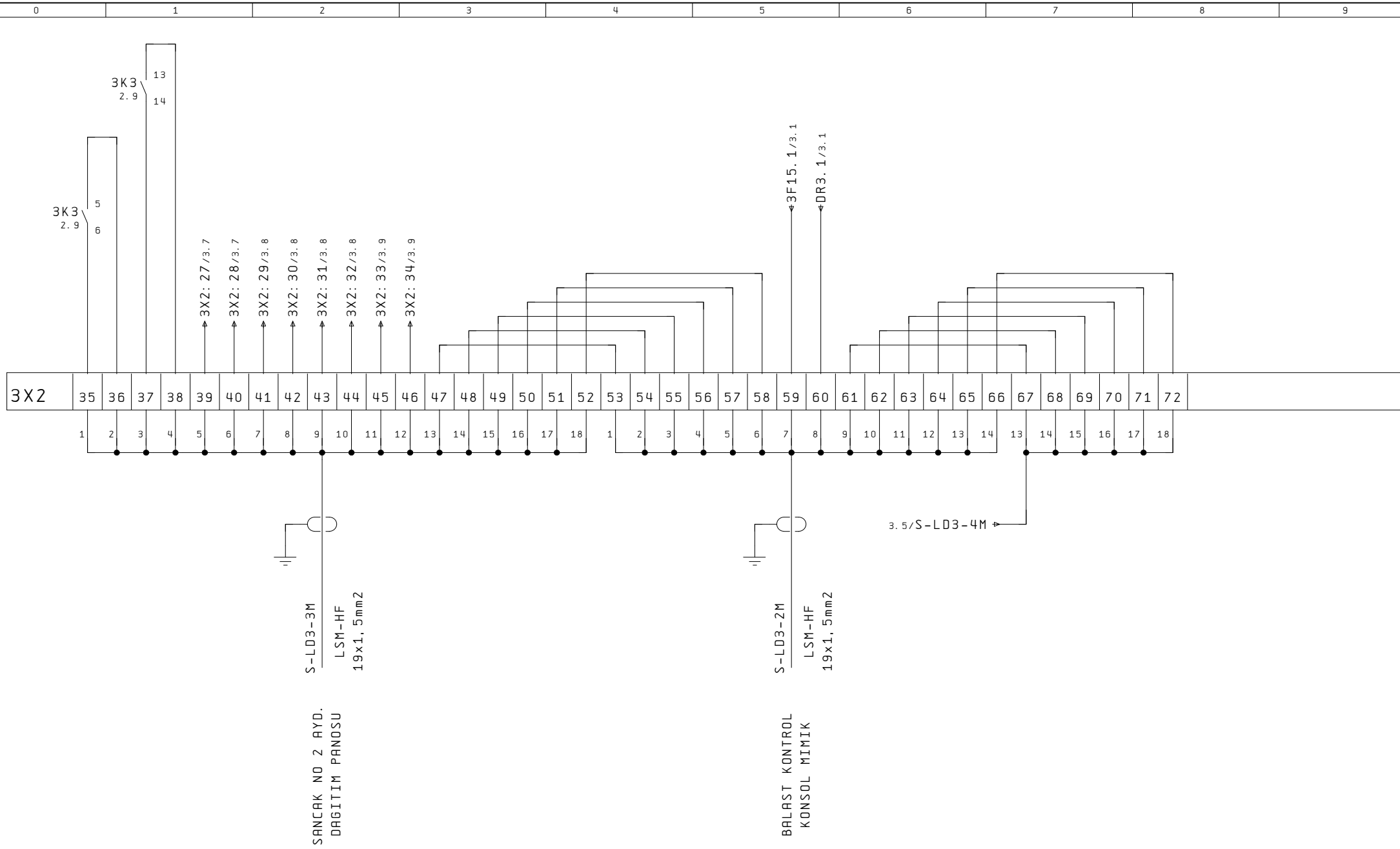

 <p>HILAL GEMİ MUHENDİSLİK</p> <p>ELEKTRİK DONANIM VE OTOMASYON SAN. TİC. LTD. STİ</p> <p>Gıptas San. Sitesi B/Blok No:30 İcmeler/TUZLA</p> <p>Tel:0216 395 60 50 GSM:0539 648 88 05</p> <p>www.hilalgemi.com</p>	DATE	SANCAK MAIN AYDINLATMA PANOSU LD3	BESIKTAS SHIPYARD	YUZER HAVUZ 3		=
	DRAWN BY				PROJE KOD	BSK/HLL-YH04
CHECKED BY			CLASS	RINA	Highest Page Number	35

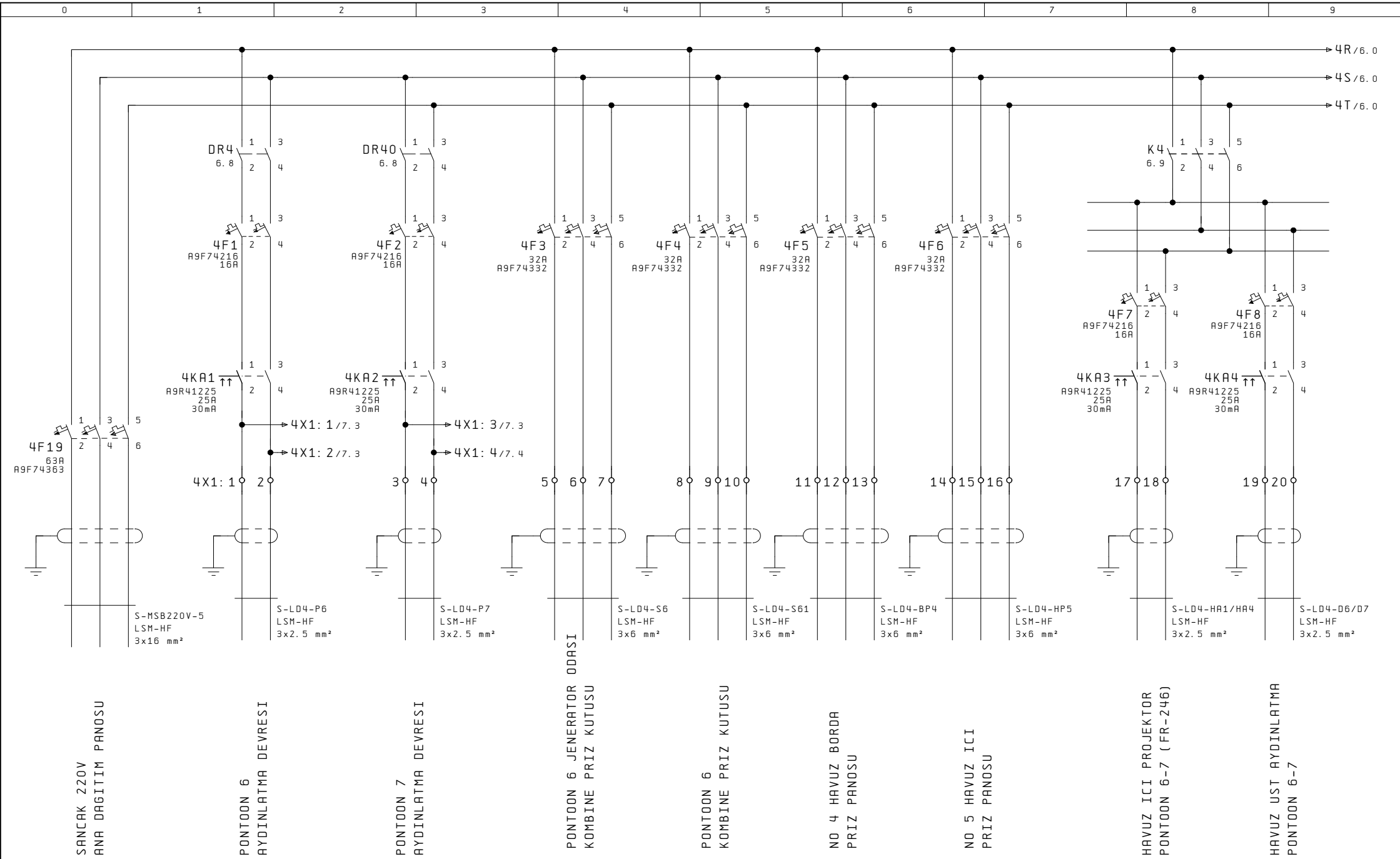

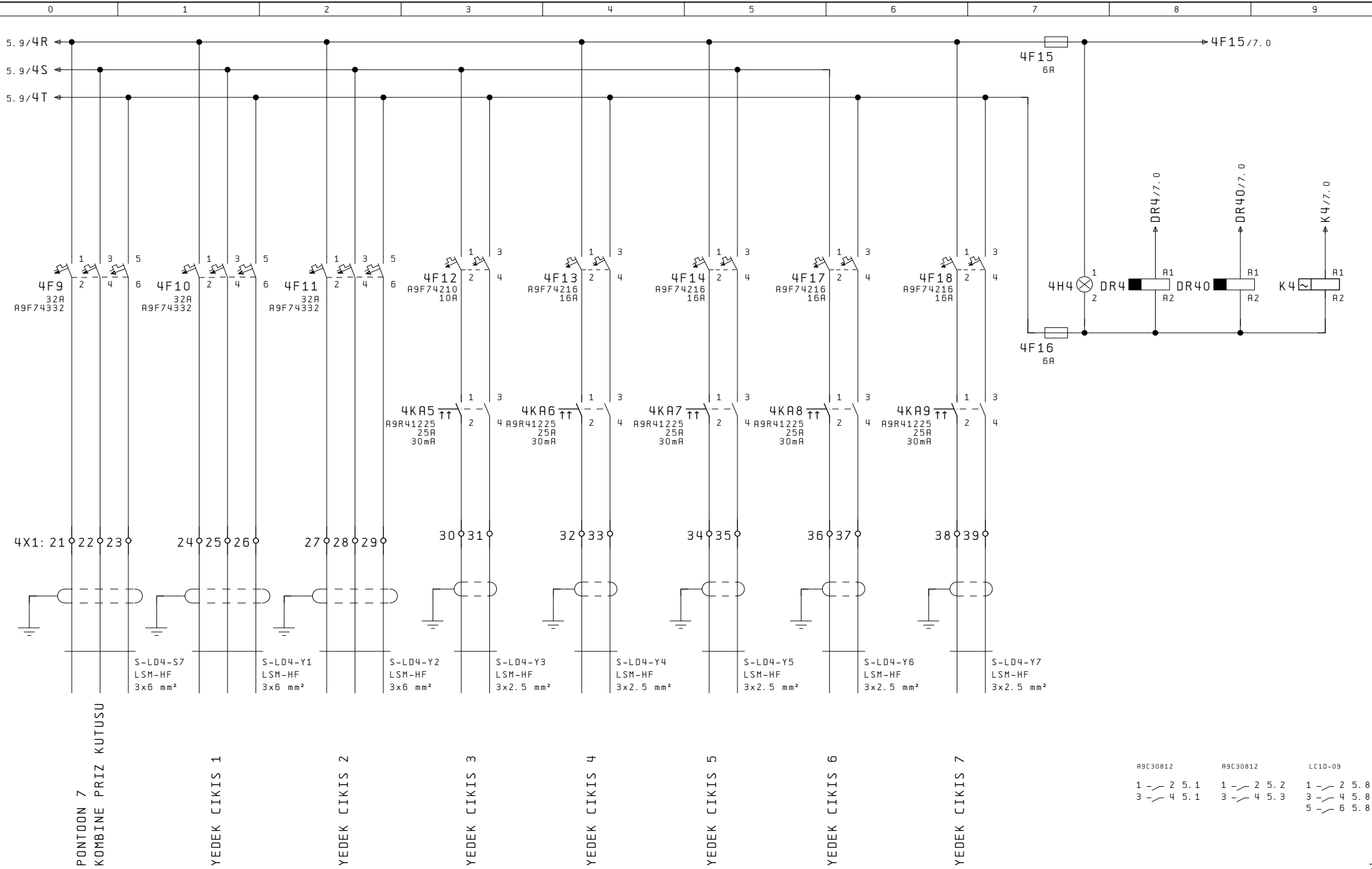

A9C30812	A9C30812	LC10-09
1 - 2 5.1	1 - 2 5.2	1 - 2 5.8
3 - 4 5.1	3 - 4 5.3	3 - 4 5.8
		5 - 6 5.8

5

7

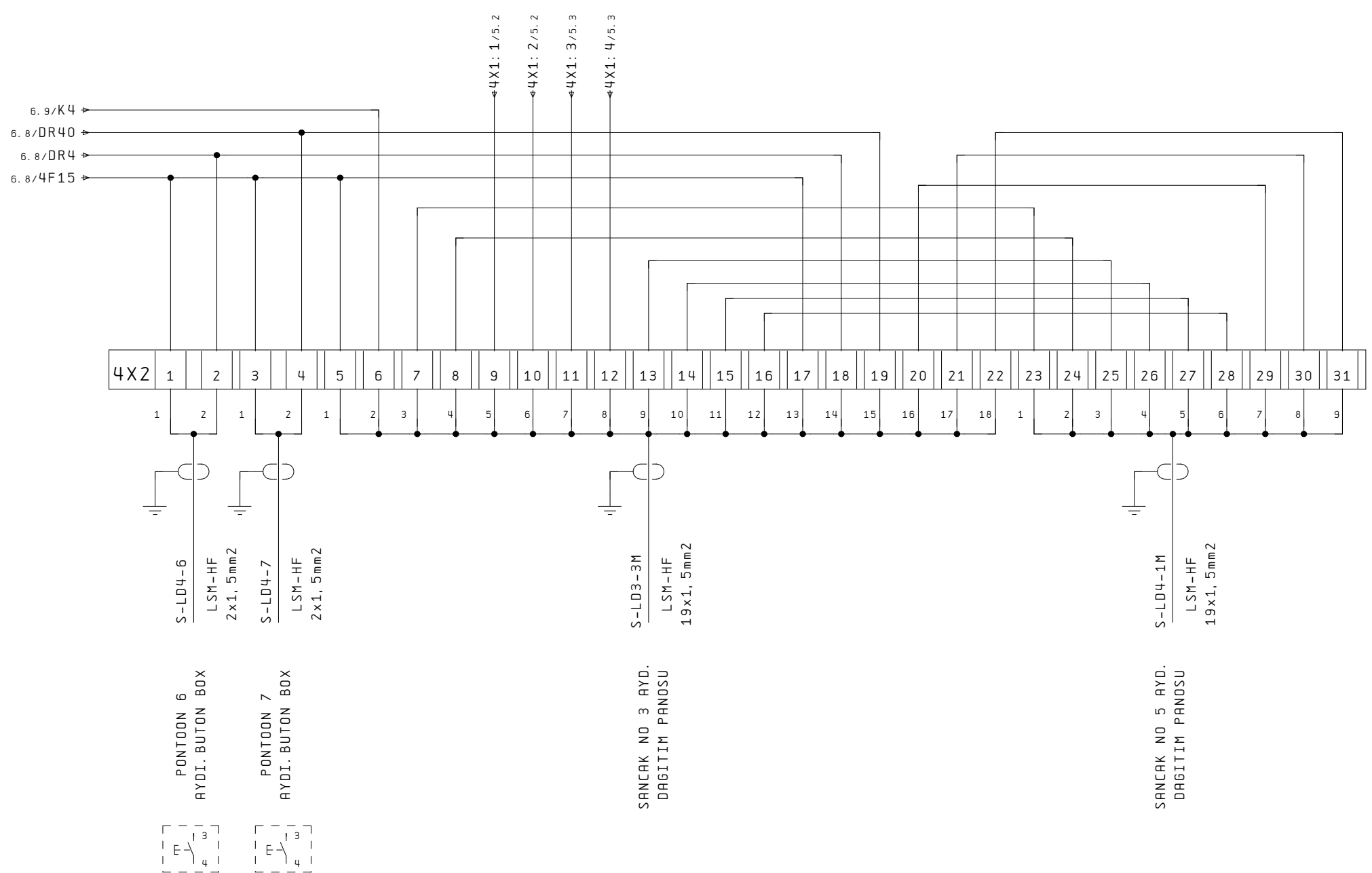

PANTOON 6
AYDI. BUTON BOX

PANTOON 7
AYDI. BUTON BOX

SANCAK NO 3 AYD.
DAGITIM PANOSU

SANCAK NO 5 AYD.
DAGITIM PANOSU

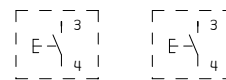

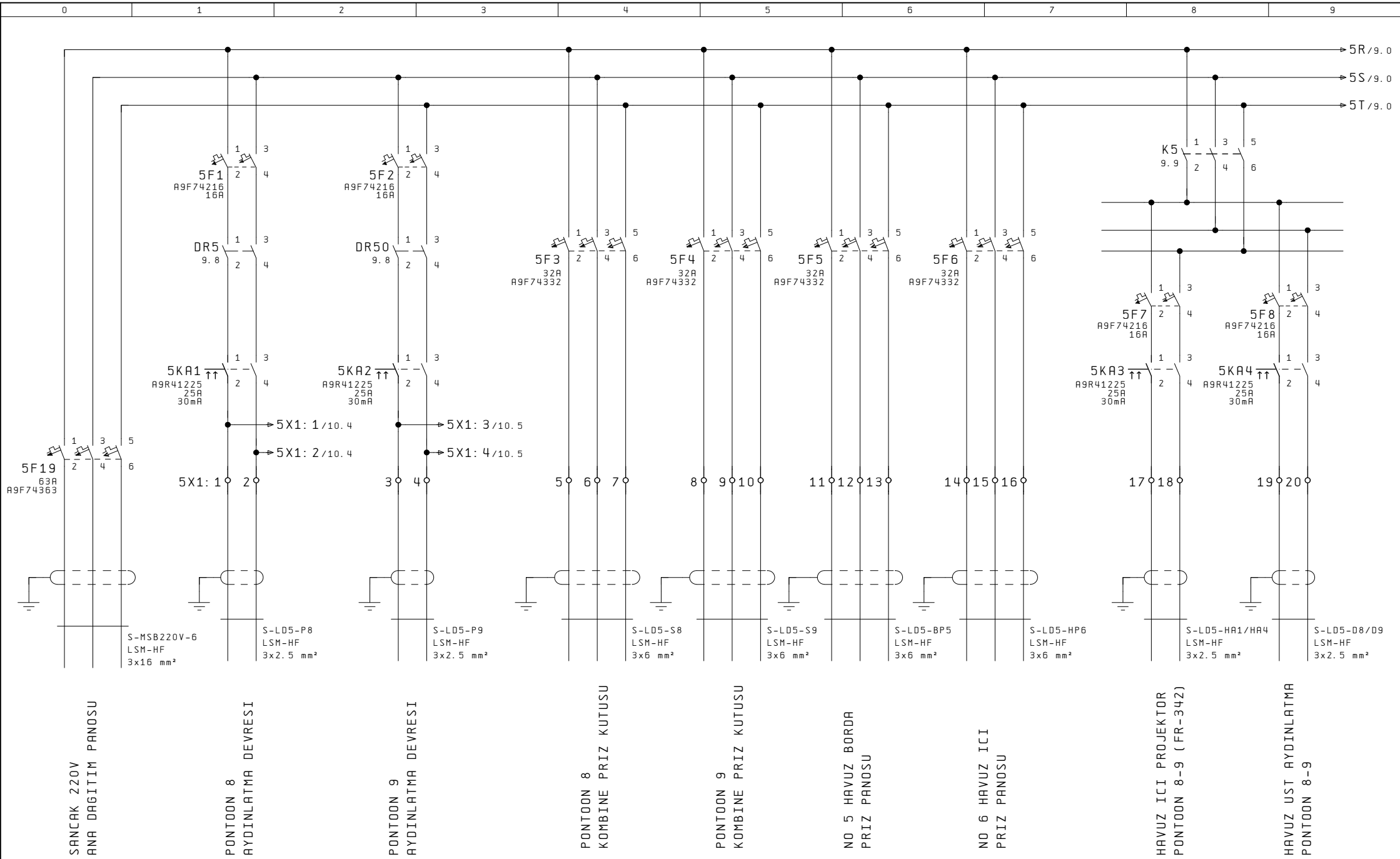

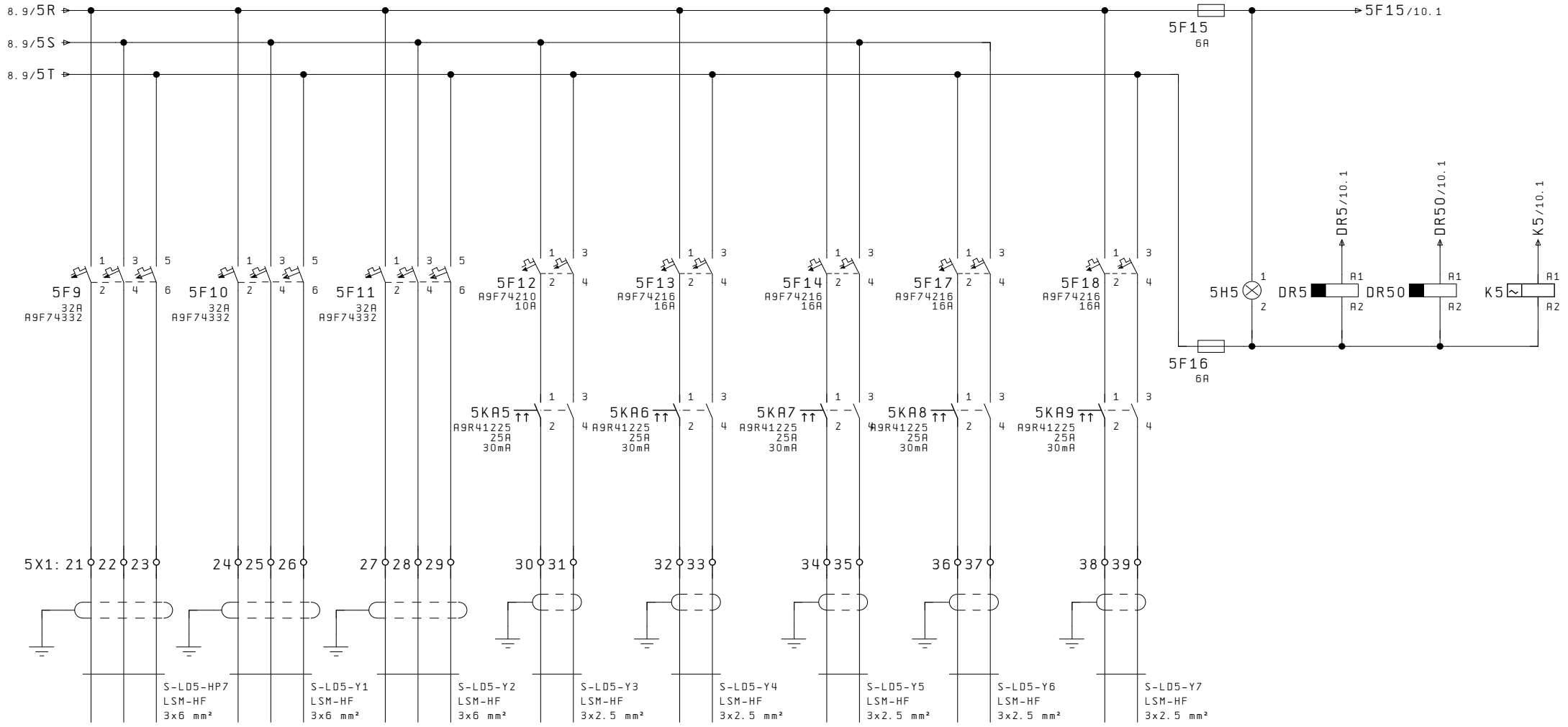

NO 7 HAVUZ ICI
PRIZ PANOSU

YEDEK CIKIS 1

YEDEK CIKIS 2

YEDEK CIKIS 3

YEDEK CIKIS 4

YEDEK CIKIS 5

YEDEK CIKIS 6

YEDEK CIKIS 7

A9C30812	A9C30812	LC10-09
1 - 2 8.1	1 - 2 8.2	1 - 2 8.8
3 - 4 8.1	3 - 4 8.3	3 - 4 8.8
		5 - 6 8.8



HILAL GEMİ MUHENDİSLİK
ELEKTRİK DONANIM VE OTOMASYON SAN. TİC. LTD. STİ
Gıptas San. Sitesi B/Blok No:30 İcmeler/TUZLA
Tel:0216 395 60 50 GSM:0539 648 88 05
www.hilalgemi.com

DATE
DRAWN BY
CHECKED BY

SANCAK MAIN AYDINLATMA PANOSU LD5

BESIKTAS SHIPYARD

YUZER HAVUZ 3
PROJE KOD BSK/HLL-YH04
CLASS RINA

Page Number 9
Highest Page Number 35

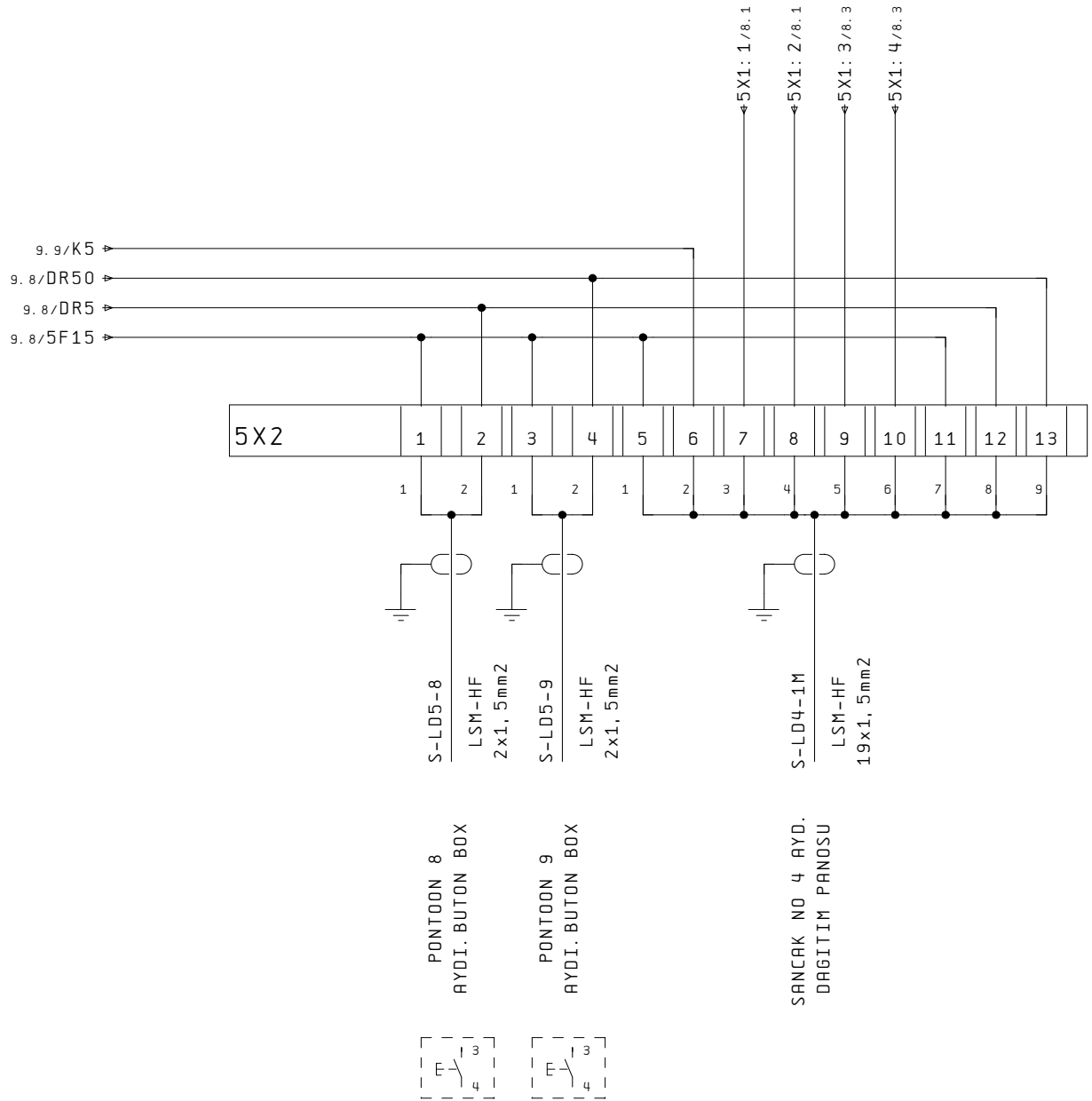

 HILAL GEMİ MUHENDİSLİK ELEKTRİK DONANIM VE OTOMASYON SAN. TİC. LTD. STİ Gıptas San. Sitesi B/Blok No:30 İcmeler/TUZLA Tel:0216 395 60 50 GSM:0539 648 88 05 www.hilalgemi.com	DATE		SANCAC MAIN AYDINLATMA PANOSU LD5	BESIKTAS SHIPYARD	YUZER HAVUZ 3		=
	DRAWN BY				PROJE KOD	BSK/HLL-YH04	Page Number
CHECKED BY		CLASS	RINA	Highest Page Number	35		

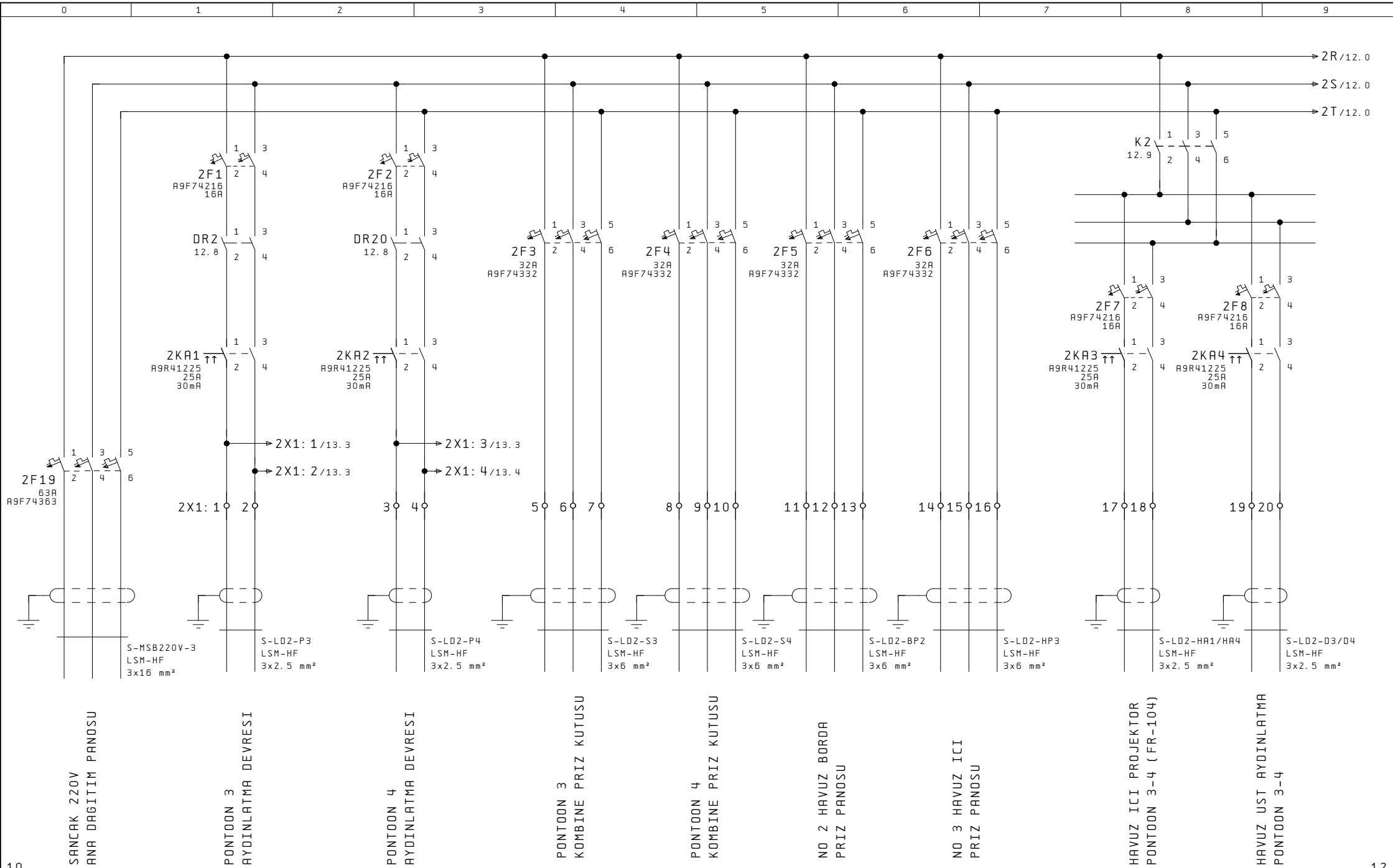

HILAL GEMİ MUHENDİSLİK
 ELEKTRİK DONANIM VE OTOMASYON SAN. TİC. LTD. STİ
 Gıptas San. Sitesi B/Blok No:30 İçmeler/TUZLA
 Tel:0216 395 60 50 GSM:0539 648 88 05
 www.hilalgemi.com

DATE
 DRAWN BY
 CHECKED BY

SANCAK MAIN AYDINLATMA PANOSU LD2

BESIKTAS SHIPYARD

YUZER HAVUZ 3

Page Number 11
 Highest Page Number 35

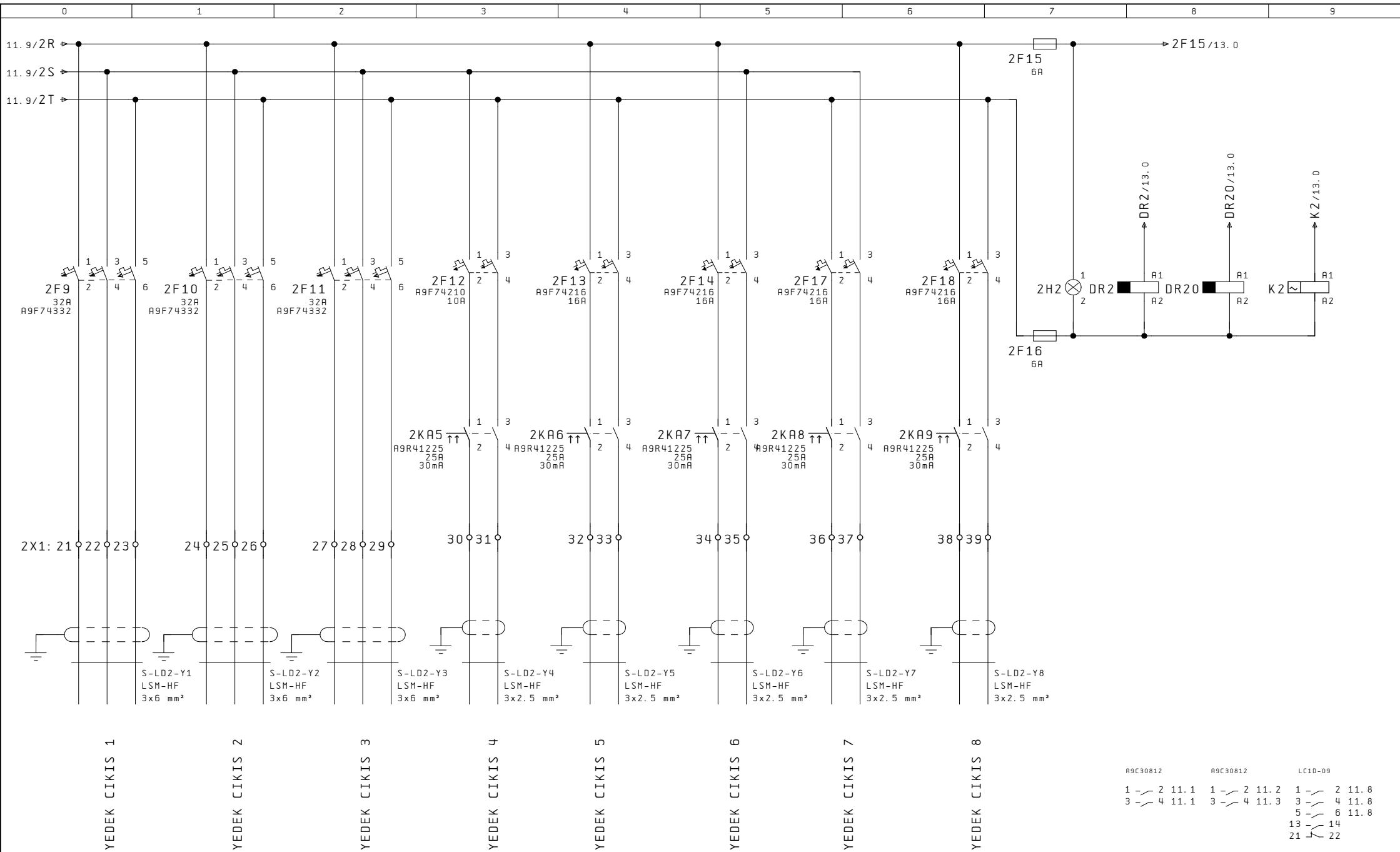

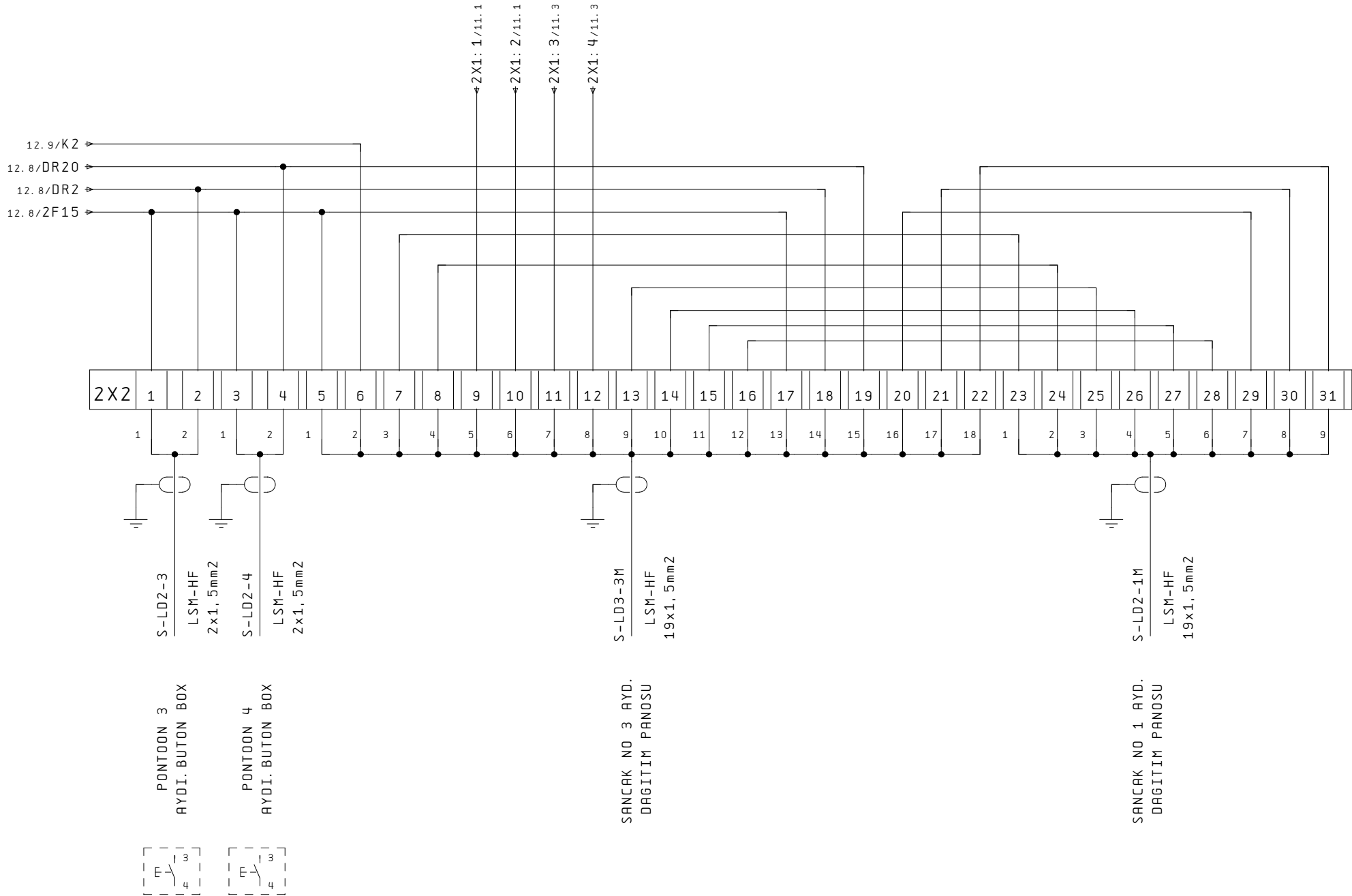

PONTON 3
AYDI. BUTON BOX

PONTON 4
AYDI. BUTON BOX

SANCAC NO 3 AYD.
DAGITIM PANOSU

SANCAC NO 1 AYD.
DAGITIM PANOSU



DATE	
DRAWN BY	
CHECKED BY	

SANCAC MAIN AYDINLATMA PANOSU LD2

BESIKTAS SHIPYARD

YUZER HAVUZ 3	
PROJE KOD	BSK/HLL-YH04
CLASS	RINA

=	
+	
Page Number	13
Highest Page Number	35

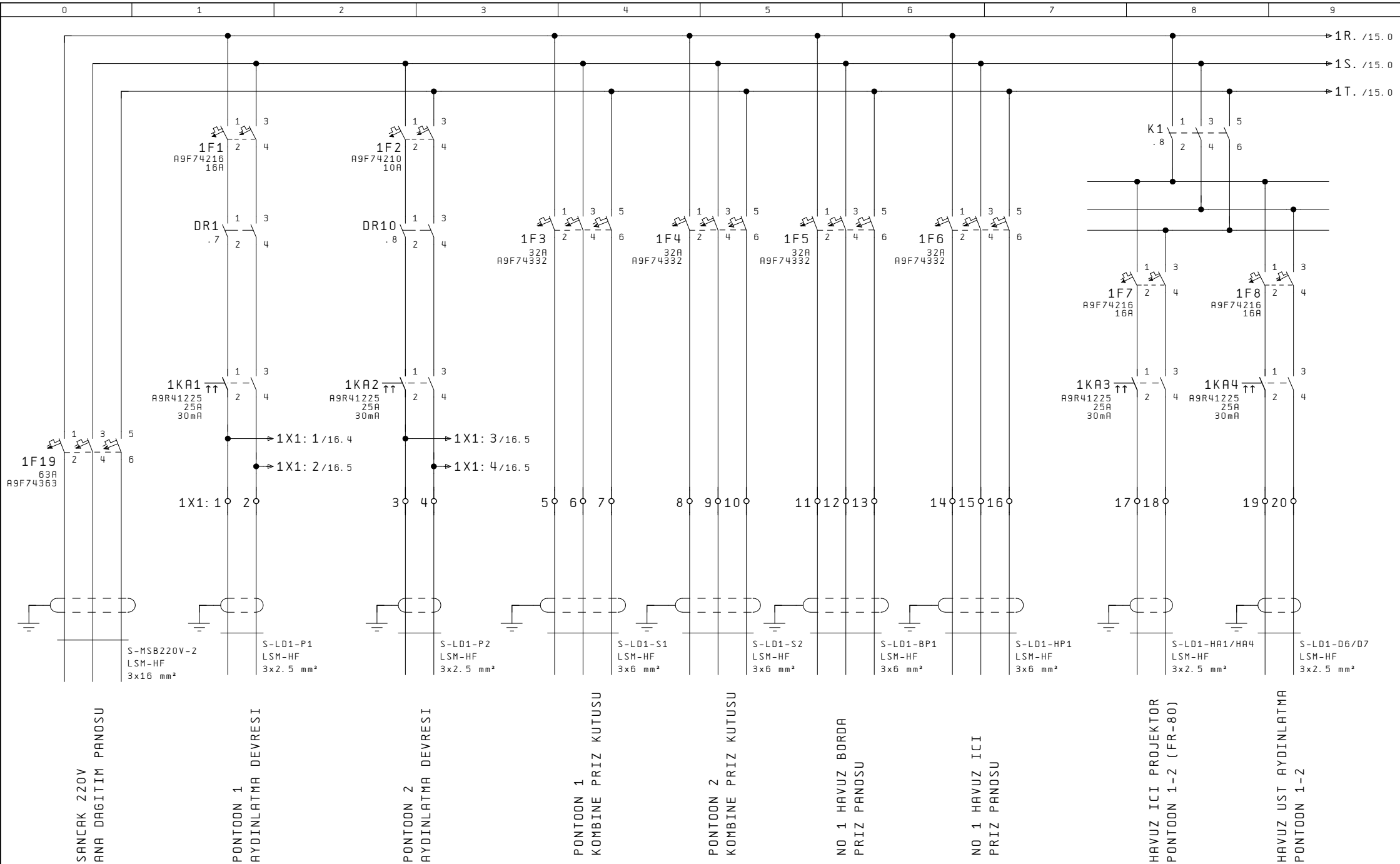

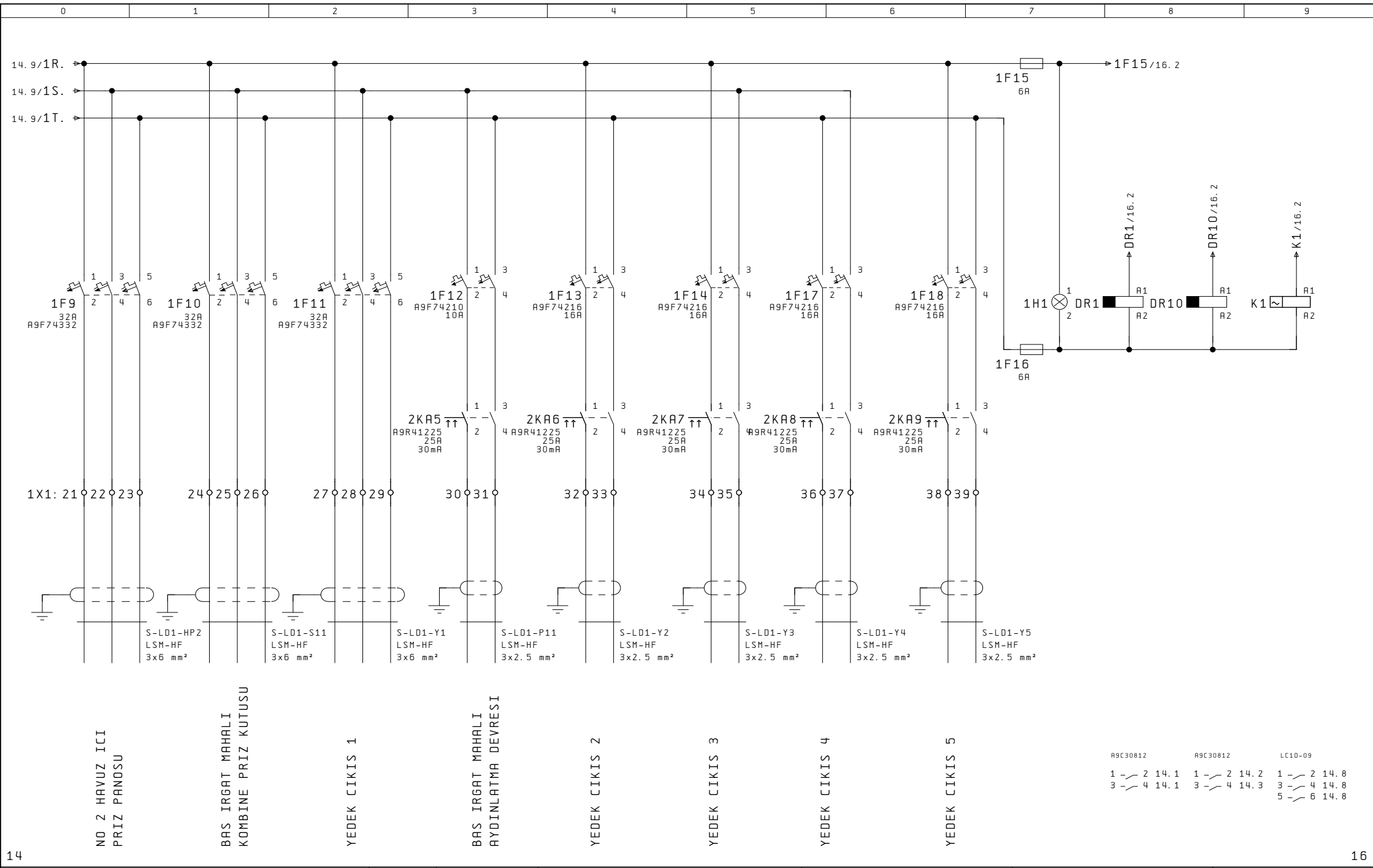

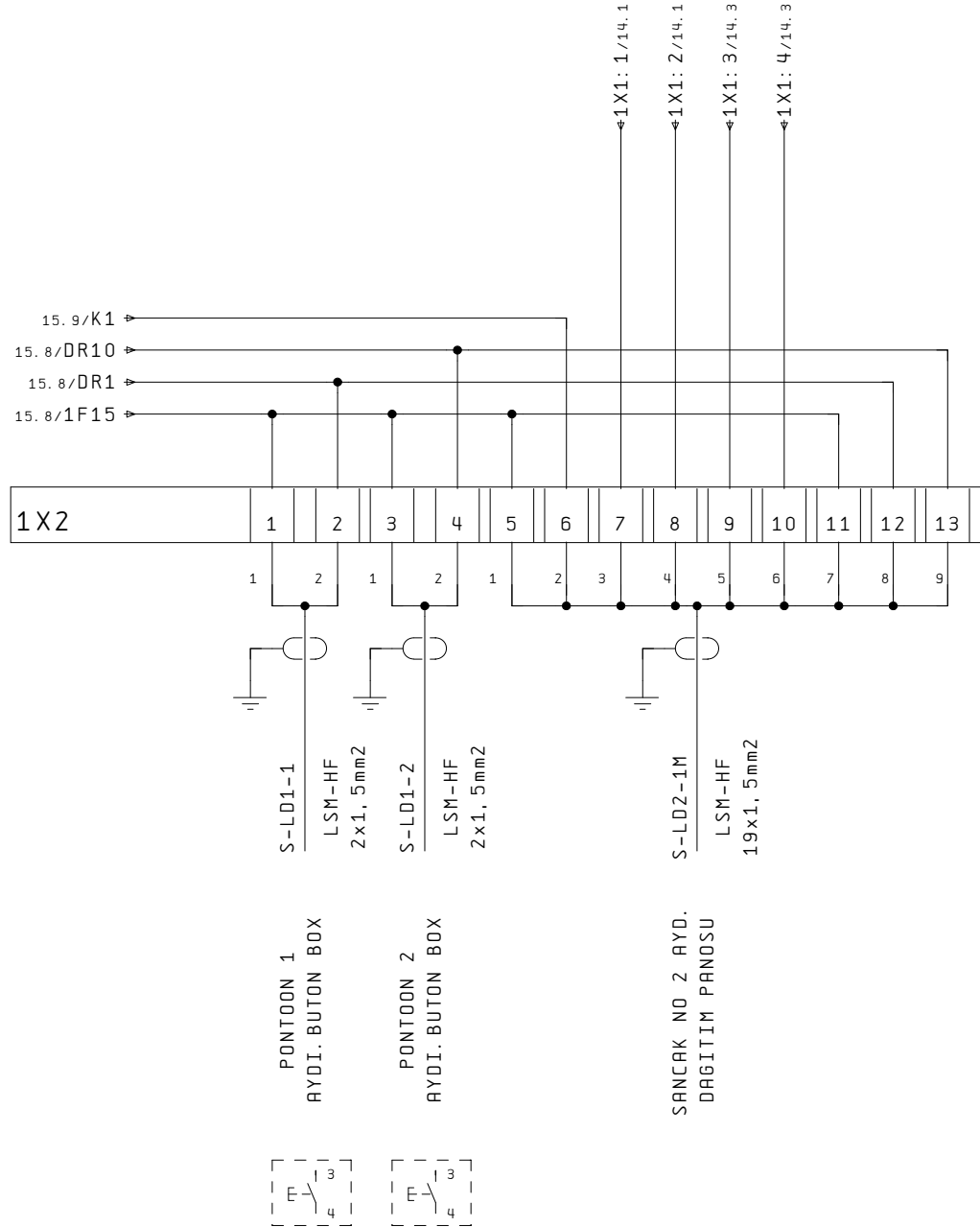

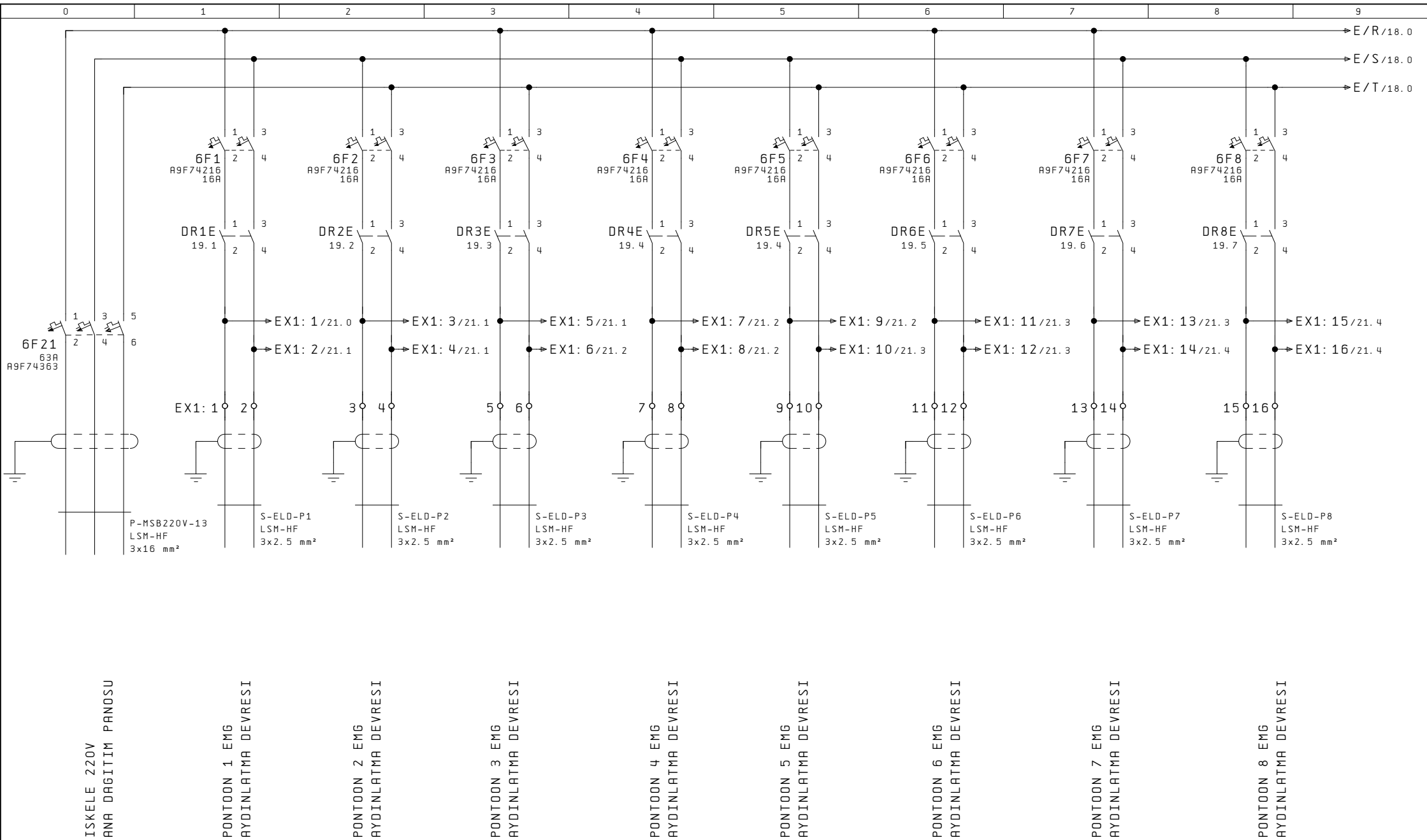

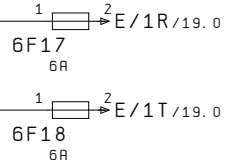
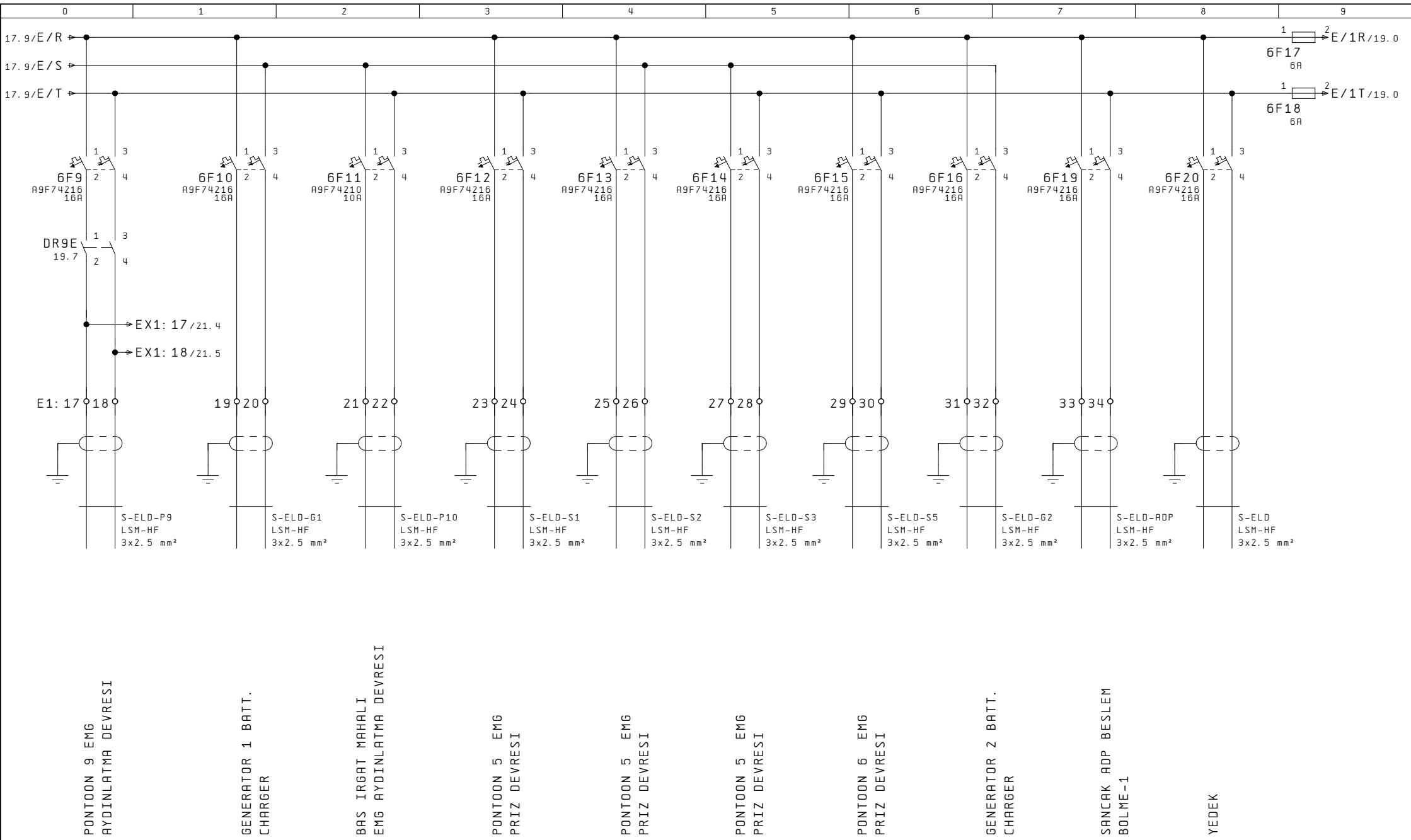

18.9/E/1R → E/1R. 1/20.2

18.9/E/1T →

DR1E/20.2

DR2E/20.2

DR3E/20.2

DR4E/20.2

DR5E/20.2

DR6E/20.2

DR7E/20.2

DR8E/20.2

DR9E/20.2

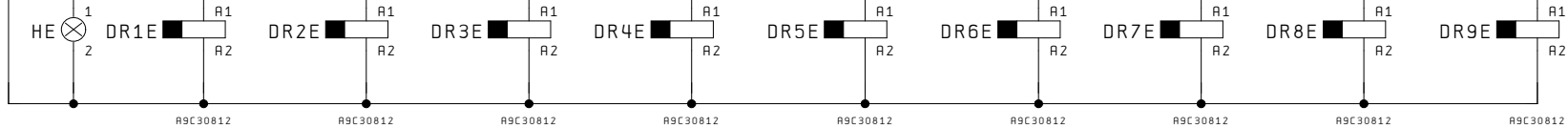

1 - 2 17.1
3 - 4 17.1

1 - 2 17.2
3 - 4 17.2

1 - 2 17.3
3 - 4 17.3

1 - 2 17.4
3 - 4 17.4

1 - 2 17.5
3 - 4 17.5

1 - 2 17.6
3 - 4 17.6

1 - 2 17.7
3 - 4 17.7

1 - 2 17.8
3 - 4 17.8

1 - 2 18.0
3 - 4 18.0



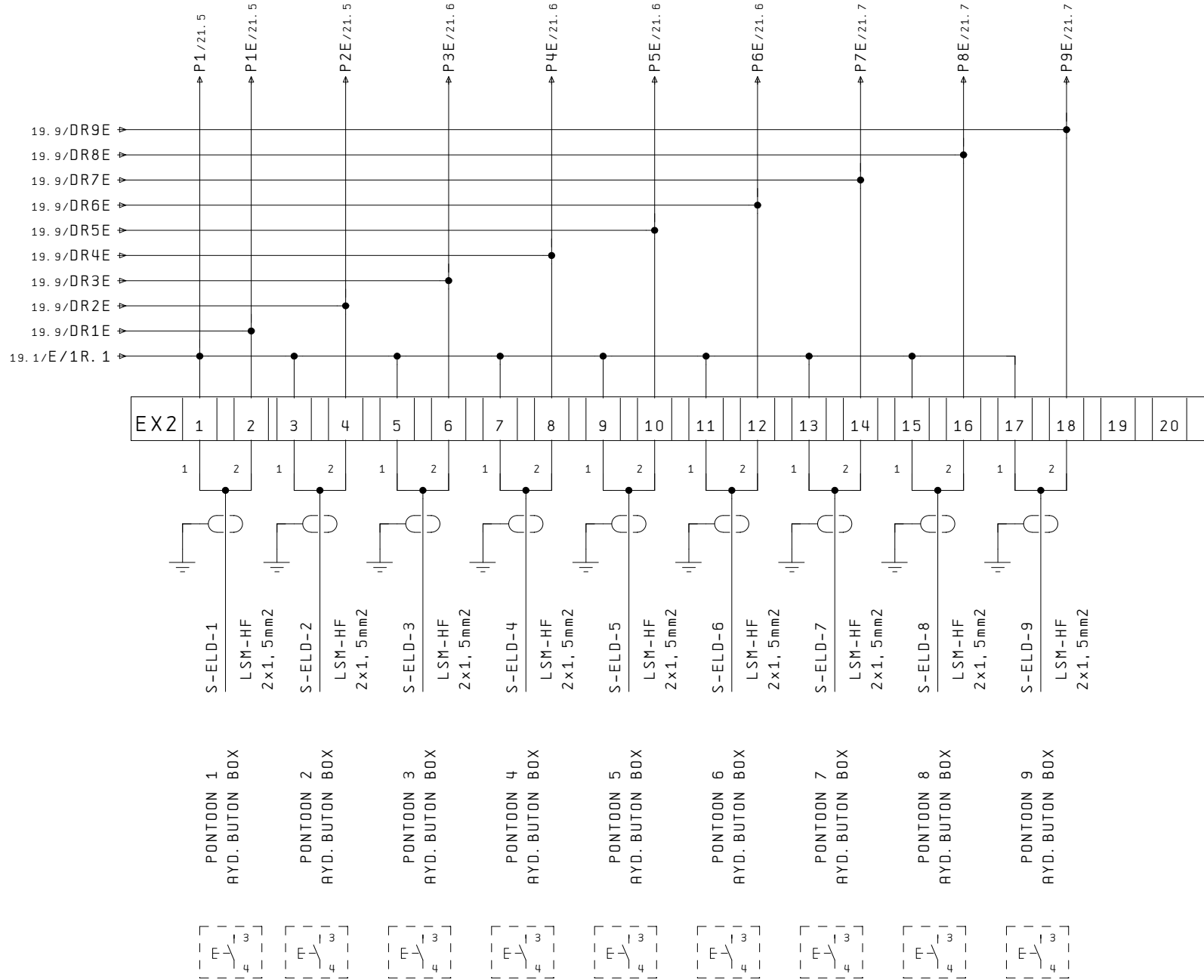

DATE	
DRAWN BY	
CHECKED BY	

SANCAK EMG AYDINLATMA PANOSU ELD

BESIKTAS SHIPYARD

YUZER HAVUZ 3	
PROJE KOD	BSK/HLL-YH04
CLASS	RINA

=	
+	
Page Number	20
Highest Page Number	35

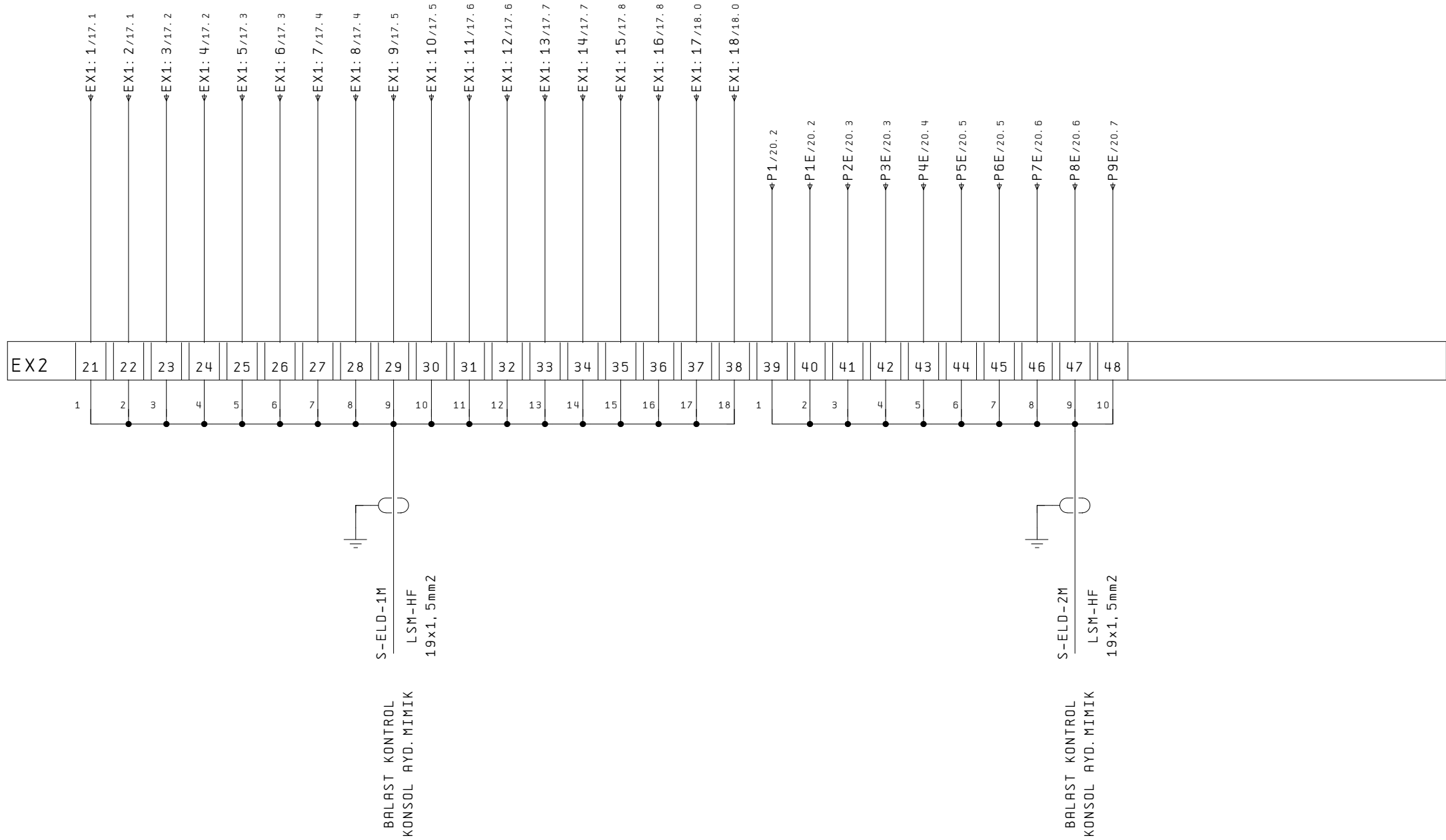

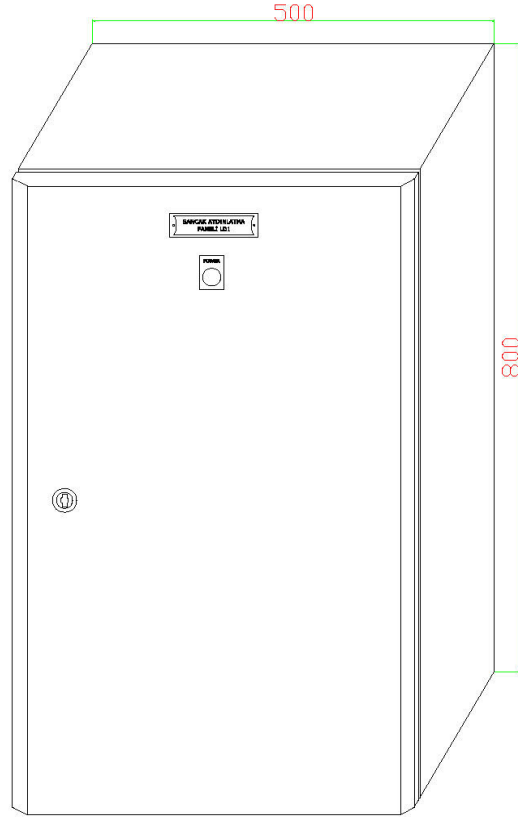

ÖNDEN GÖRÜNÜŞ

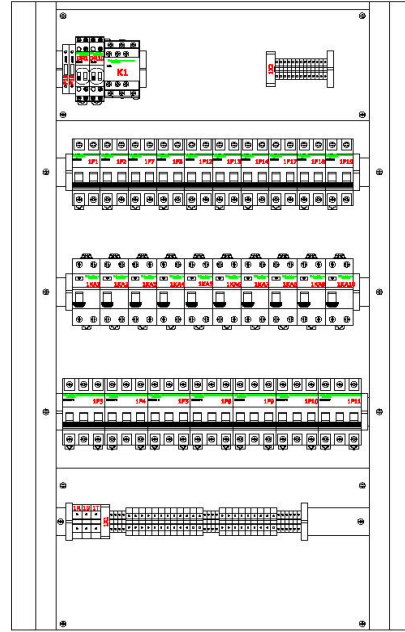

İÇ YERLEŞİM GÖRÜNÜŞ

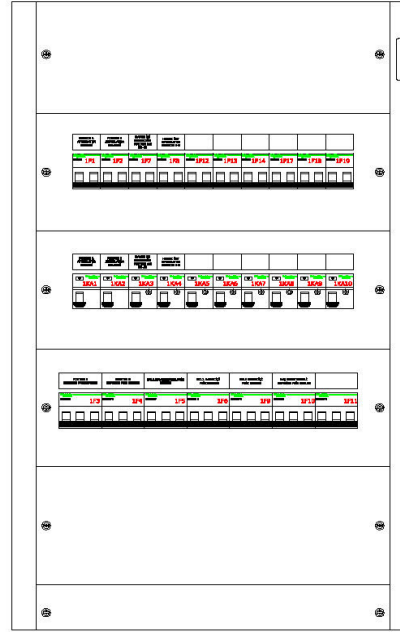

EMNİYETLİ İÇ GÖRÜNÜŞ

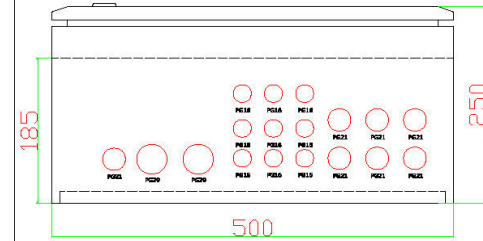

PANO ALT REKOR GİRİŞİ GÖRÜNÜŞ

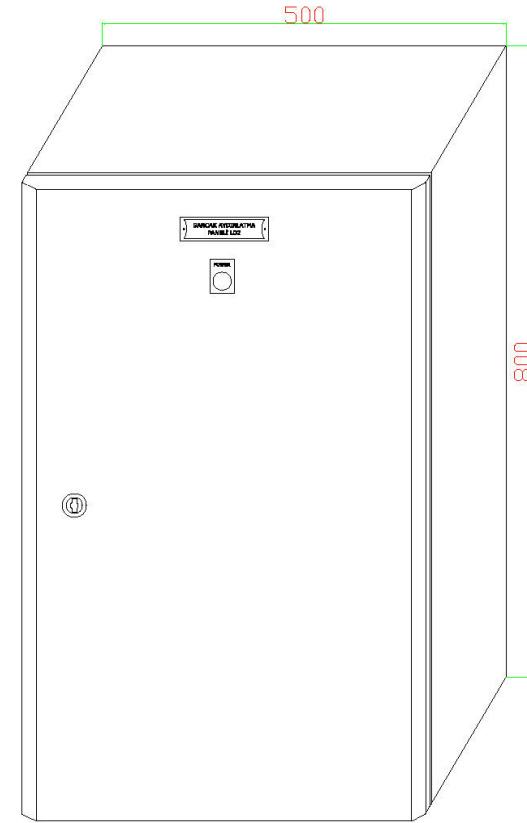

ÖNDEN GÖRÜNÜŞ

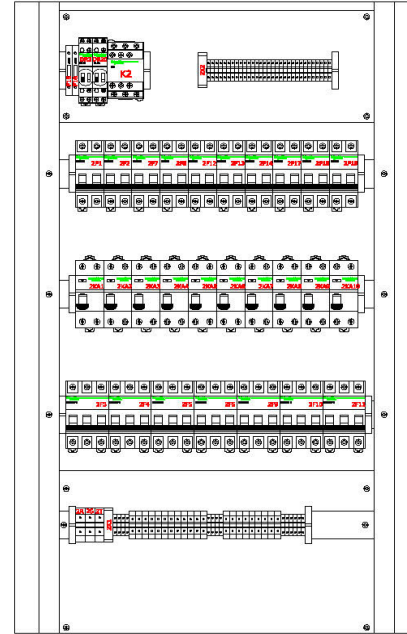

İÇ YERLEŞİM GÖRÜNÜŞ

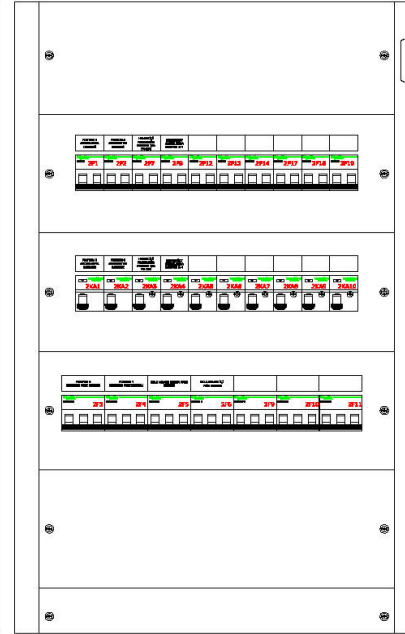

EMNİYETLİ İÇ GÖRÜNÜŞ

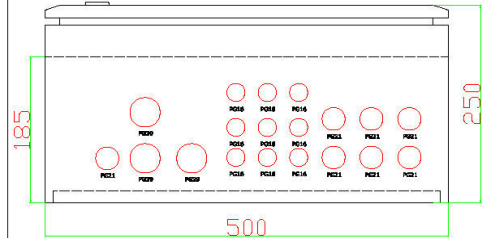

PANO ALT REKOR GİRİŞİ
GÖRÜNÜŞ

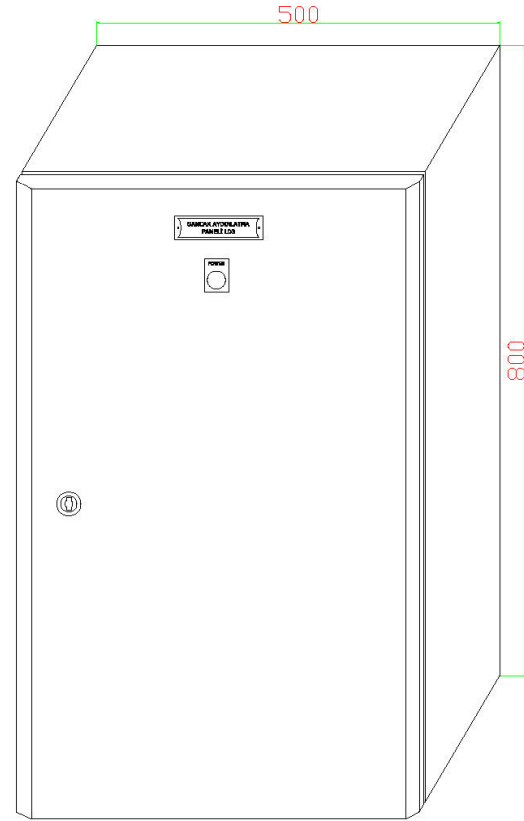

ÖNDEN GÖRÜNÜŞ

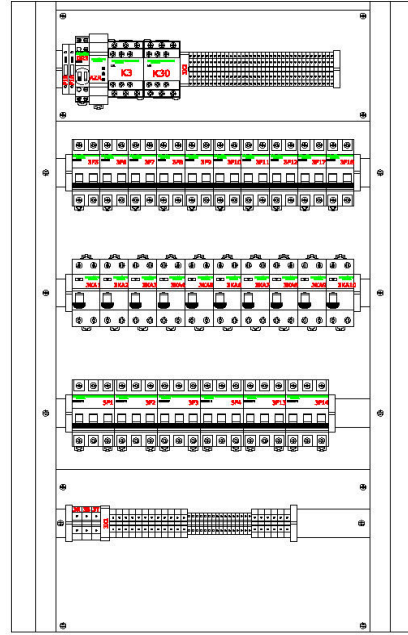

İÇ YERLEŞİM GÖRÜNÜŞ

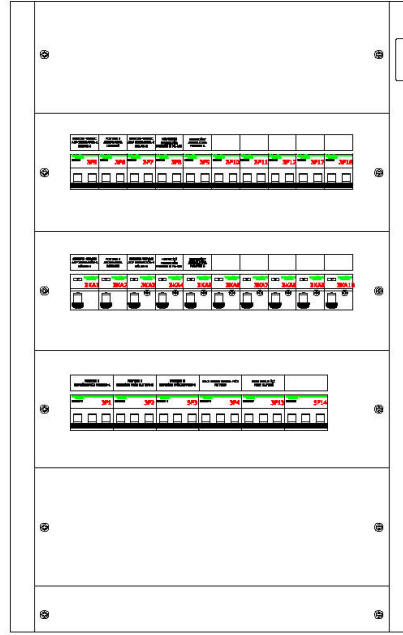

EMNİYETLİ İÇ GÖRÜNÜŞ

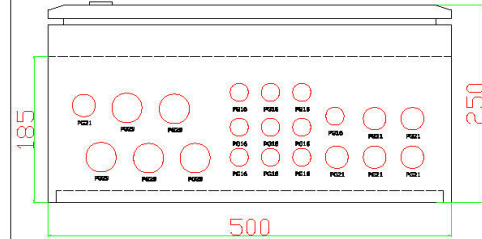

PANO ALT REKOR GİRİŞİ
GÖRÜNÜŞ

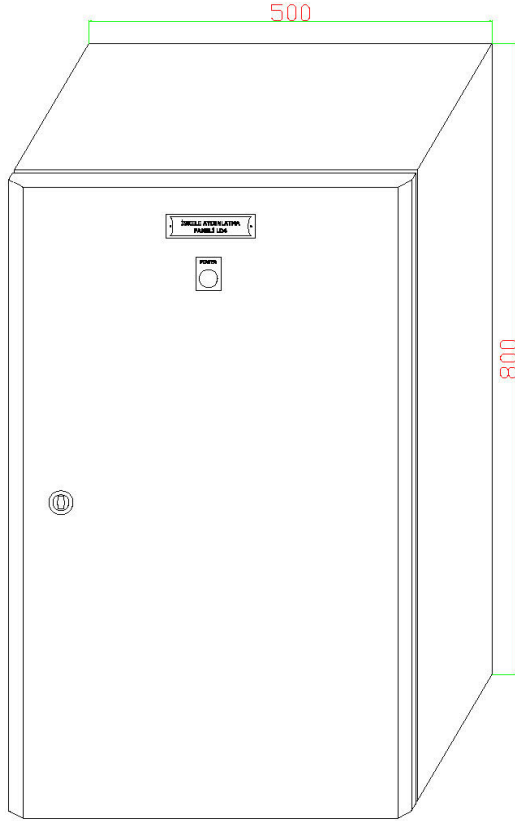

ÖNDEN GÖRÜNÜŞ

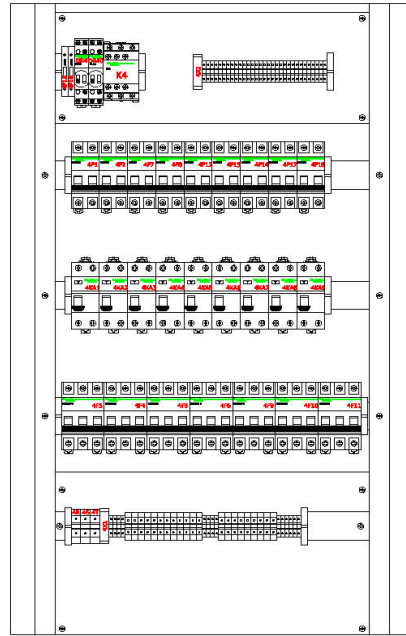

İÇ YERLEŞİM GÖRÜNÜŞ

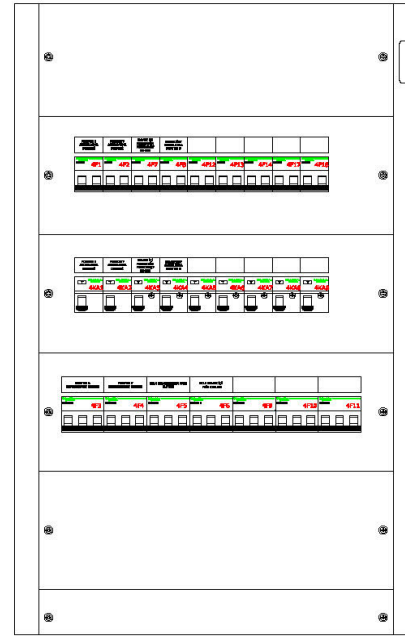

EMNİYETLİ İÇ GÖRÜNÜŞ

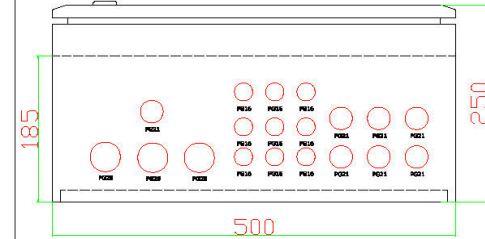

PANO ALT REKOR GİRİŞİ GÖRÜNÜŞ

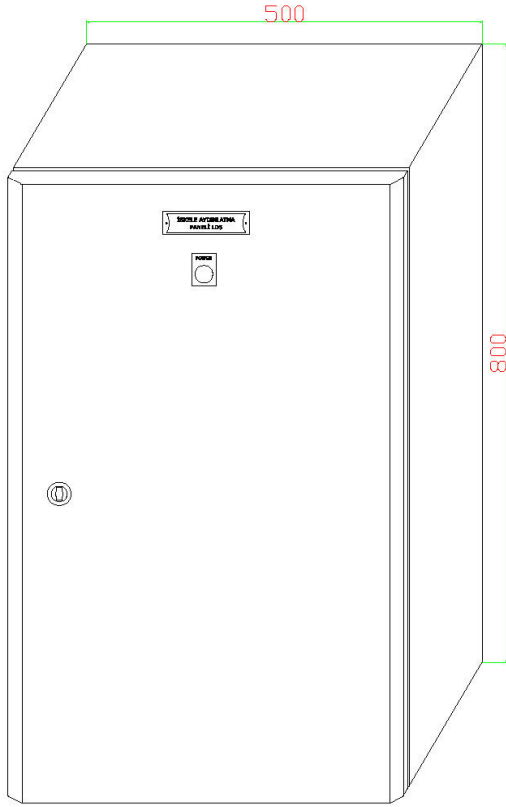

ÖNDEN GÖRÜNÜŞ

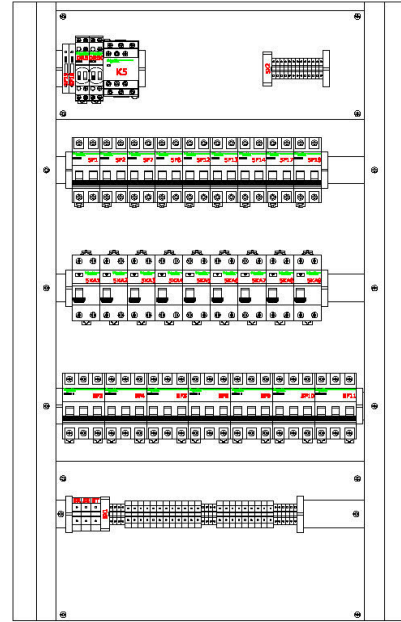

İÇ YERLEŞİM GÖRÜNÜŞ

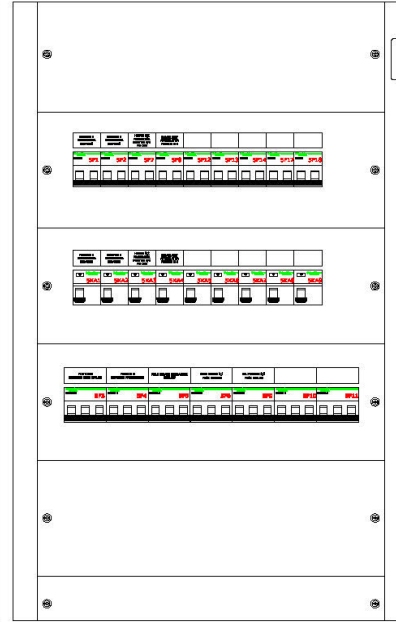

EMNİYETLİ İÇ GÖRÜNÜŞ

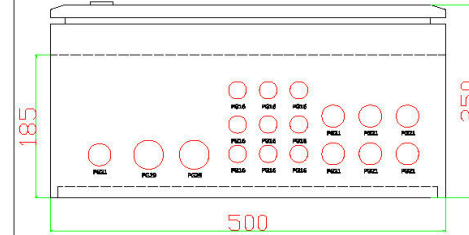

PANO ALT REKOR GİRİŞİ
GÖRÜNÜŞ

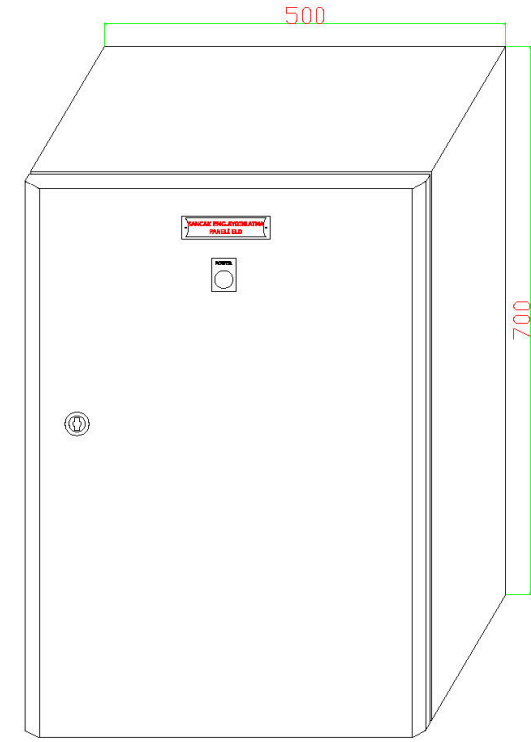

ÖNDEN GÖRÜNÜŞ

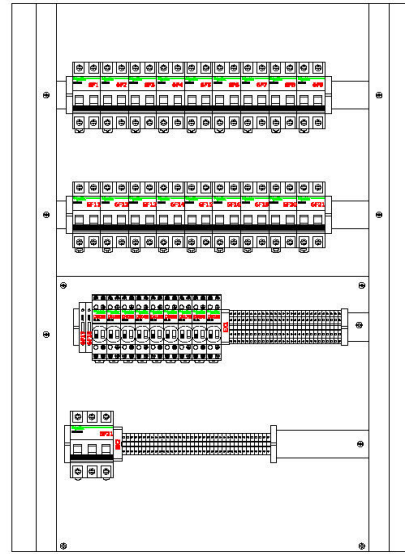

İÇ YERLEŞİM GÖRÜNÜŞ

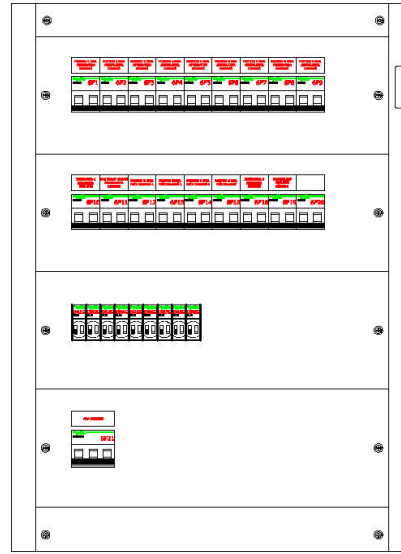

EMNİYETLİ İÇ GÖRÜNÜŞ

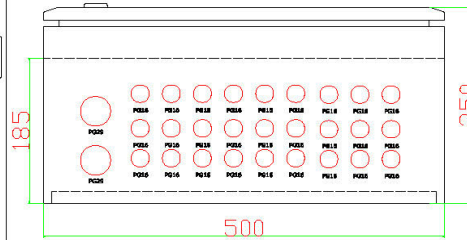

PANO ALT REKOR GİRİŞİ
GÖRÜNÜŞ

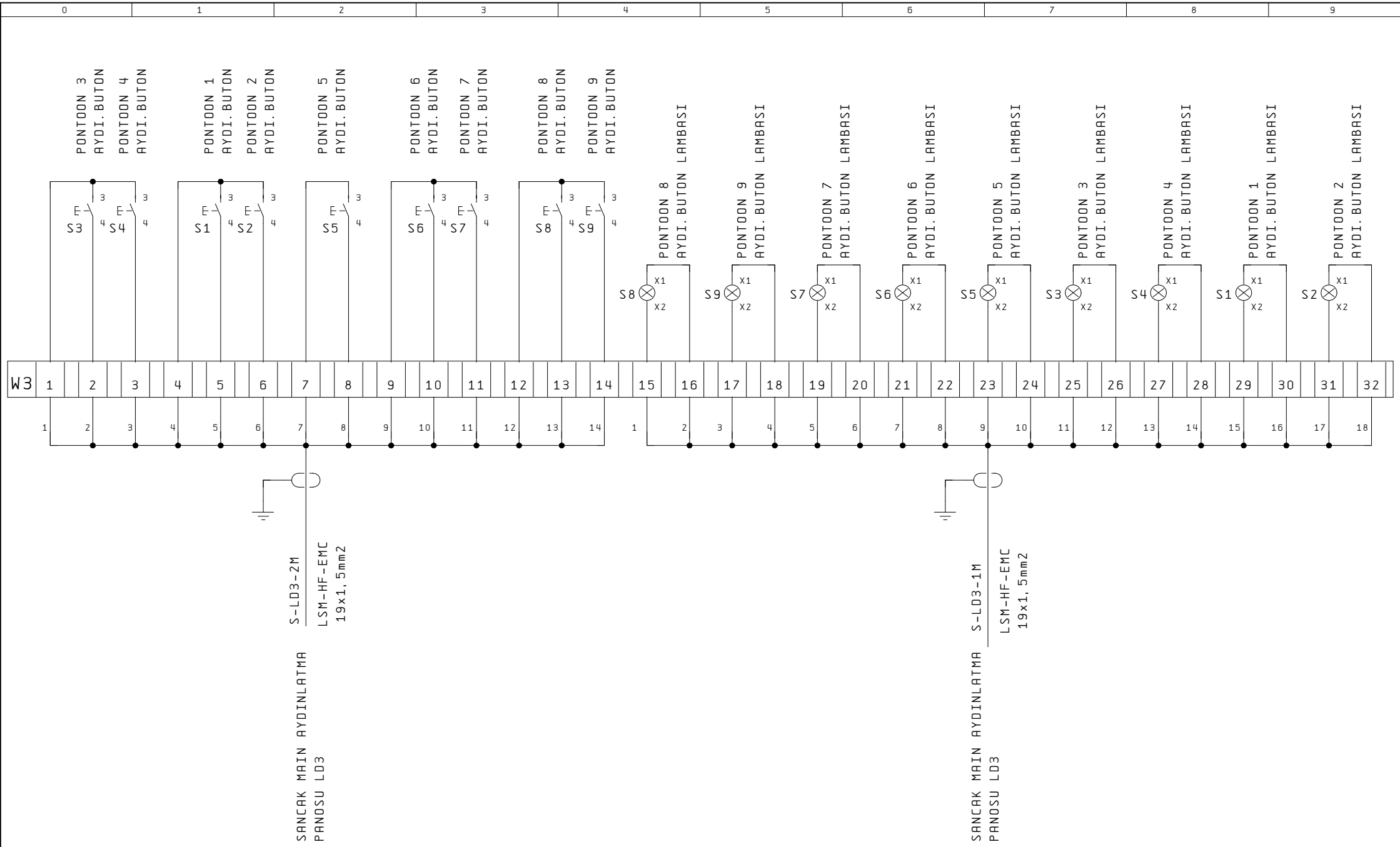

DATE	
DRAWN BY	
CHECKED BY	

SANC AK EMG AYDINLATMA PANOSU ELD

BESIKTAS SHIPYARD

YUZER HAVUZ 3	
PROJE KOD	BSK/HLL-YH04
CLASS	RINA

=	
+	
Page Number	28
Highest Page Number	35

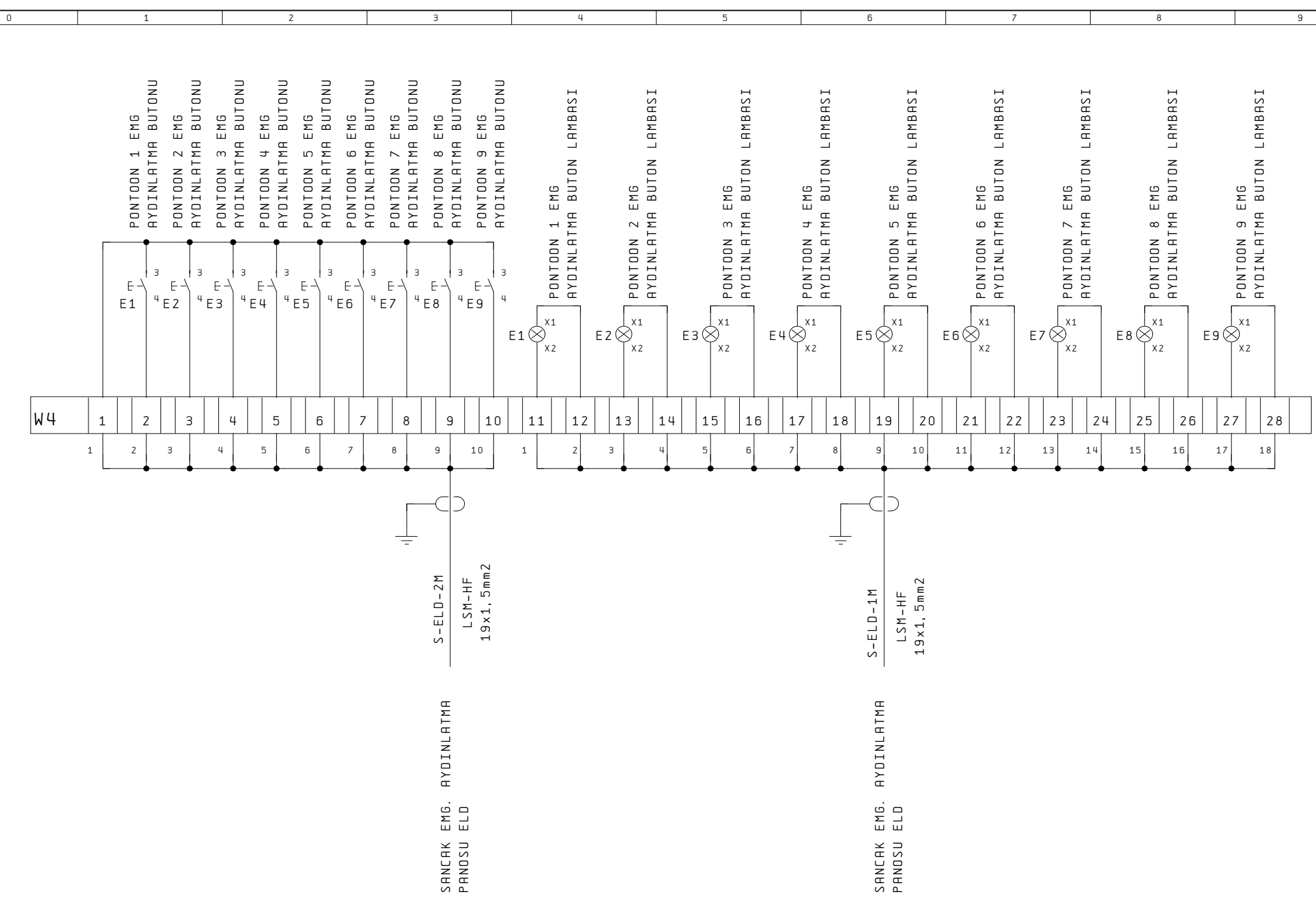

SANCAK EMG. AYDINLATMA
PANOSU ELD

SANCAK EMG. AYDINLATMA
PANOSU ELD



DATE	
DRAWN BY	
CHECKED BY	

SANCAK EMG AYDINLATMA PANOSU ELD

BESIKTAS SHIPYARD

YUZER HAVUZ 3	
PROJE KOD	BSK/HLL-YH04
CLASS	RINA

Page Number	29
Highest Page Number	35

384

160

HAVUZ SANCAK PONTON ANA AYDINLATMA PANELİ

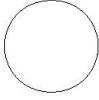
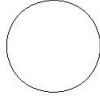
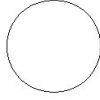
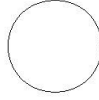
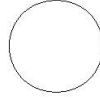
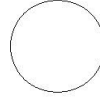
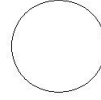
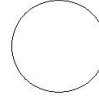
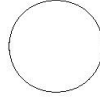
PONTON-1 ANA
AYDINLATMA
AÇ/KAPAPONTON-2 ANA
AYDINLATMA
AÇ/KAPAPONTON-3 ANA
AYDINLATMA
AÇ/KAPAPONTON-4 ANA
AYDINLATMA
AÇ/KAPAPONTON-5 ANA
AYDINLATMA
AÇ/KAPAPONTON-6 ANA
AYDINLATMA
AÇ/KAPAPONTON-7 ANA
AYDINLATMA
AÇ/KAPAPONTON-8 ANA
AYDINLATMA
AÇ/KAPAPONTON-9 ANA
AYDINLATMA
AÇ/KAPA

HAVUZ SANCAK PONTON EMG. AYDINLATMA PANELİ

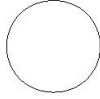
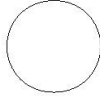
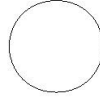
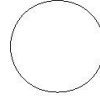
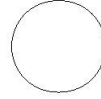
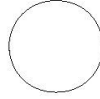
PONTON-1 EMG.
AYDINLATMA
AÇ/KAPAPONTON-2 EMG.
AYDINLATMA
AÇ/KAPAPONTON-3 EMG.
AYDINLATMA
AÇ/KAPAPONTON-4 EMG.
AYDINLATMA
AÇ/KAPAPONTON-5 EMG.
AYDINLATMA
AÇ/KAPAPONTON-6 EMG.
AYDINLATMA
AÇ/KAPAPONTON-7 EMG.
AYDINLATMA
AÇ/KAPAPONTON-8 EMG.
AYDINLATMA
AÇ/KAPAPONTON-9 EMG.
AYDINLATMA
AÇ/KAPA

Bill of materials

Item	Amount	Designation	Type	Manufacturer	Article number	Note
3F19	1	MINIATURE CIRCIUT BREAKER 63A	C60N 3P	SCHNEIDER	A9F74363	
3F1	1	MINIATURE CIRCIUT BREAKER 32A	C60N 3P	SCHNEIDER	A9F74332	
X	102	RAY KLEMENS 6mm2	304 140	KLEMSAN	AVK 6	
3F2	1	MINIATURE CIRCIUT BREAKER 32A	C60N 3P	SCHNEIDER	A9F74332	
3F3	1	MINIATURE CIRCIUT BREAKER 32A	C60N 3P	SCHNEIDER	A9F74332	
3F4	1	MINIATURE CIRCIUT BREAKER 32A	C60N 3P	SCHNEIDER	A9F74332	
3F5	1	MINIATURE CIRCIUT BREAKER 16A	C60N 2P	SCHNEIDER	A9F74216	
3KA1	1	LEAKAGE RELAY 25A 30mA		SCHNEIDER	A9R41225 25A	
X	500	RAY KLEMENS 2.5mm2	304 120	KLEMSAN	AVK 2.5	
3F6	1	MINIATURE CIRCIUT BREAKER 16A	C60N 2P	SCHNEIDER	A9F74216	
3KA2	1	LEAKAGE RELAY 25A 30mA		SCHNEIDER	A9R41225 25A	
3F7	1	MINIATURE CIRCIUT BREAKER 10A	C60N 2P	SCHNEIDER	A9F74210	
3KA3	1	LEAKAGE RELAY 25A 30mA		SCHNEIDER	A9R41225 25A	
3F8	1	MINIATURE CIRCIUT BREAKER 10A	C60N 2P	SCHNEIDER	A9F74210	
3KA4	1	LEAKAGE RELAY 25A 30mA		SCHNEIDER	A9R41225 25A	
3F9	1	MINIATURE CIRCIUT BREAKER 10A	C60N 2P	SCHNEIDER	A9F74210	
3KA5	1	LEAKAGE RELAY 25A 30mA		SCHNEIDER	A9R41225 25A	
3F10	1	MINIATURE CIRCIUT BREAKER 16A	C60N 2P	SCHNEIDER	A9F74216	
3KA6	1	LEAKAGE RELAY 25A 30mA		SCHNEIDER	A9R41225 25A	
3F11	1	MINIATURE CIRCIUT BREAKER 16A	C60N 2P	SCHNEIDER	A9F74216	
3KA7	1	LEAKAGE RELAY 25A 30mA		SCHNEIDER	A9R41225 25A	
3F12	1	MINIATURE CIRCIUT BREAKER 10A	C60N 2P	SCHNEIDER	A9F74210	
3KA8	1	LEAKAGE RELAY 25A 30mA		SCHNEIDER	A9R41225 25A	
3F13	1	MINIATURE CIRCIUT BREAKER 32A	C60N 3P	SCHNEIDER	A9F74332	
3F14	1	MINIATURE CIRCIUT BREAKER 32A	C60N 3P	SCHNEIDER	A9F74332	
3F17	1	MINIATURE CIRCIUT BREAKER 16A	C60N 2P	SCHNEIDER	A9F74216	
3KA9	1	LEAKAGE RELAY 25A 30mA		SCHNEIDER	A9R41225 25A	
3F18	1	MINIATURE CIRCIUT BREAKER 16A	C60N 2P	SCHNEIDER	A9F74216	
3KA10	1	LEAKAGE RELAY 25A 30mA		SCHNEIDER	A9R41225 25A	
3F15	1	SIGORTALI KLEMENS 6mm2 6.3A	351 109	KLEMSAN	ASK 2S	
3F16	1	SIGORTALI KLEMENS 6mm2 6.3A	351 109	KLEMSAN	ASK 2S	
3H3	1	INDICATING LAMP WHITE	XB7-EV01MP	Telemecanique	XB7-EV01MP	
3DR3	1	IMPACT CB. SWITCH 2P 16A	ITL	SCHNEIDER	A9C30812	
3DR3	1	IMPACT CB. SWITCH 2P 16A	ITL	SCHNEIDER	A9C30812	
3DR30	1	IMPACT CB. SWITCH 2P 16A	ITL	SCHNEIDER	A9C30812	
3DR30	1	IMPACT CB. SWITCH 2P 16A	ITL	SCHNEIDER	A9C30812	
AZR	1	TIMER REEL RELAY	15336	SCHNEIDER	ARM-15336	
3K3	1	POWER CONTACTOR 4kW		SCHNEIDER	LC1D-09-LAD-N22	
4F1	1	MINIATURE CIRCIUT BREAKER 16A	C60N 2P	SCHNEIDER	A9F74216	
4KA1	1	LEAKAGE RELAY 25A 30mA		SCHNEIDER	A9R41225 25A	
4F2	1	MINIATURE CIRCIUT BREAKER 16A	C60N 2P	SCHNEIDER	A9F74216	
4KA2	1	LEAKAGE RELAY 25A 30mA		SCHNEIDER	A9R41225 25A	
4F3	1	MINIATURE CIRCIUT BREAKER 32A	C60N 3P	SCHNEIDER	A9F74332	
4F4	1	MINIATURE CIRCIUT BREAKER 32A	C60N 3P	SCHNEIDER	A9F74332	
4F5	1	MINIATURE CIRCIUT BREAKER 32A	C60N 3P	SCHNEIDER	A9F74332	
4F6	1	MINIATURE CIRCIUT BREAKER 32A	C60N 3P	SCHNEIDER	A9F74332	
4F7	1	MINIATURE CIRCIUT BREAKER 16A	C60N 2P	SCHNEIDER	A9F74216	
4KA3	1	LEAKAGE RELAY 25A 30mA		SCHNEIDER	A9R41225 25A	
4F8	1	MINIATURE CIRCIUT BREAKER 16A	C60N 2P	SCHNEIDER	A9F74216	
4KA4	1	LEAKAGE RELAY 25A 30mA		SCHNEIDER	A9R41225 25A	

Bill of materials

Item	Amount	Designation	Type	Manufacturer	Article number	Note
4F9	1	MINIATURE CIRCIUT BREAKER 32A	C60N 3P	SCHNEIDER	A9F74332	
4F10	1	MINIATURE CIRCIUT BREAKER 32A	C60N 3P	SCHNEIDER	A9F74332	
4F11	1	MINIATURE CIRCIUT BREAKER 32A	C60N 3P	SCHNEIDER	A9F74332	
4F12	1	MINIATURE CIRCIUT BREAKER 10A	C60N 2P	SCHNEIDER	A9F74210	
4KA5	1	LEAKAGE RELAY 25A 30mA		SCHNEIDER	A9R41225 25A	
4F13	1	MINIATURE CIRCIUT BREAKER 16A	C60N 2P	SCHNEIDER	A9F74216	
4KA6	1	LEAKAGE RELAY 25A 30mA		SCHNEIDER	A9R41225 25A	
4F14	1	MINIATURE CIRCIUT BREAKER 16A	C60N 2P	SCHNEIDER	A9F74216	
4KA7	1	LEAKAGE RELAY 25A 30mA		SCHNEIDER	A9R41225 25A	
4F17	1	MINIATURE CIRCIUT BREAKER 16A	C60N 2P	SCHNEIDER	A9F74216	
4KA8	1	LEAKAGE RELAY 25A 30mA		SCHNEIDER	A9R41225 25A	
4F18	1	MINIATURE CIRCIUT BREAKER 16A	C60N 2P	SCHNEIDER	A9F74216	
4KA9	1	LEAKAGE RELAY 25A 30mA		SCHNEIDER	A9R41225 25A	
4F15	1	SIGORTALI KLEMENS 6mm2 6.3A	351 109	KLEMSAN	ASK 2S	
4F16	1	SIGORTALI KLEMENS 6mm2 6.3A	351 109	KLEMSAN	ASK 2S	
DR4	1	IMPACT CB. SWITCH 2P 16A	ITL	SCHNEIDER	A9C30812	
DR40	1	IMPACT CB. SWITCH 2P 16A	ITL	SCHNEIDER	A9C30812	
K4	1	POWER CONTACTOR 4kW		SCHNEIDER	LC1D-09	
5F1	1	MINIATURE CIRCIUT BREAKER 16A	C60N 2P	SCHNEIDER	A9F74216	
5KA1	1	LEAKAGE RELAY 25A 30mA		SCHNEIDER	A9R41225 25A	
5F2	1	MINIATURE CIRCIUT BREAKER 16A	C60N 2P	SCHNEIDER	A9F74216	
5KA2	1	LEAKAGE RELAY 25A 30mA		SCHNEIDER	A9R41225 25A	
5F3	1	MINIATURE CIRCIUT BREAKER 32A	C60N 3P	SCHNEIDER	A9F74332	
5F4	1	MINIATURE CIRCIUT BREAKER 32A	C60N 3P	SCHNEIDER	A9F74332	
5F5	1	MINIATURE CIRCIUT BREAKER 32A	C60N 3P	SCHNEIDER	A9F74332	
5F6	1	MINIATURE CIRCIUT BREAKER 32A	C60N 3P	SCHNEIDER	A9F74332	
5F7	1	MINIATURE CIRCIUT BREAKER 16A	C60N 2P	SCHNEIDER	A9F74216	
5KA3	1	LEAKAGE RELAY 25A 30mA		SCHNEIDER	A9R41225 25A	
5F8	1	MINIATURE CIRCIUT BREAKER 16A	C60N 2P	SCHNEIDER	A9F74216	
5KA4	1	LEAKAGE RELAY 25A 30mA		SCHNEIDER	A9R41225 25A	
5F9	1	MINIATURE CIRCIUT BREAKER 32A	C60N 3P	SCHNEIDER	A9F74332	
5F10	1	MINIATURE CIRCIUT BREAKER 32A	C60N 3P	SCHNEIDER	A9F74332	
5F11	1	MINIATURE CIRCIUT BREAKER 32A	C60N 3P	SCHNEIDER	A9F74332	
5F12	1	MINIATURE CIRCIUT BREAKER 10A	C60N 2P	SCHNEIDER	A9F74210	
5KA5	1	LEAKAGE RELAY 25A 30mA		SCHNEIDER	A9R41225 25A	
5F13	1	MINIATURE CIRCIUT BREAKER 16A	C60N 2P	SCHNEIDER	A9F74216	
5KA6	1	LEAKAGE RELAY 25A 30mA		SCHNEIDER	A9R41225 25A	
5F14	1	MINIATURE CIRCIUT BREAKER 16A	C60N 2P	SCHNEIDER	A9F74216	
5KA7	1	LEAKAGE RELAY 25A 30mA		SCHNEIDER	A9R41225 25A	
5F17	1	MINIATURE CIRCIUT BREAKER 16A	C60N 2P	SCHNEIDER	A9F74216	
5KA8	1	LEAKAGE RELAY 25A 30mA		SCHNEIDER	A9R41225 25A	
5F18	1	MINIATURE CIRCIUT BREAKER 16A	C60N 2P	SCHNEIDER	A9F74216	
5KA9	1	LEAKAGE RELAY 25A 30mA		SCHNEIDER	A9R41225 25A	
5F15	1	SIGORTALI KLEMENS 6mm2 6.3A	351 109	KLEMSAN	ASK 2S	
5F16	1	SIGORTALI KLEMENS 6mm2 6.3A	351 109	KLEMSAN	ASK 2S	
DR5	1	IMPACT CB. SWITCH 2P 16A	ITL	SCHNEIDER	A9C30812	
DR50	1	IMPACT CB. SWITCH 2P 16A	ITL	SCHNEIDER	A9C30812	
K5	1	POWER CONTACTOR 4kW		SCHNEIDER	LC1D-09	
2F1	1	MINIATURE CIRCIUT BREAKER 16A	C60N 2P	SCHNEIDER	A9F74216	
2KA1	1	LEAKAGE RELAY 25A 30mA		SCHNEIDER	A9R41225 25A	

Bill of materials

Item	Amount	Designation	Type	Manufacturer	Article number	Note
2F2	1	MINIATURE CIRCIUT BREAKER 16A	C60N 2P	SCHNEIDER	A9F74216	
2KA2	1	LEAKAGE RELAY 25A 30mA			A9R41225 25A	
2F3	1	MINIATURE CIRCIUT BREAKER 32A	C60N 3P	SCHNEIDER	A9F74332	
2F4	1	MINIATURE CIRCIUT BREAKER 32A	C60N 3P	SCHNEIDER	A9F74332	
2F5	1	MINIATURE CIRCIUT BREAKER 32A	C60N 3P	SCHNEIDER	A9F74332	
2F6	1	MINIATURE CIRCIUT BREAKER 32A	C60N 3P	SCHNEIDER	A9F74332	
2F7	1	MINIATURE CIRCIUT BREAKER 16A	C60N 2P	SCHNEIDER	A9F74216	
2KA3	1	LEAKAGE RELAY 25A 30mA			A9R41225 25A	
2F8	1	MINIATURE CIRCIUT BREAKER 16A	C60N 2P	SCHNEIDER	A9F74216	
2KA4	1	LEAKAGE RELAY 25A 30mA			A9R41225 25A	
2F9	1	MINIATURE CIRCIUT BREAKER 32A	C60N 3P	SCHNEIDER	A9F74332	
2F10	1	MINIATURE CIRCIUT BREAKER 32A	C60N 3P	SCHNEIDER	A9F74332	
2F11	1	MINIATURE CIRCIUT BREAKER 32A	C60N 3P	SCHNEIDER	A9F74332	
2F12	1	MINIATURE CIRCIUT BREAKER 10A	C60N 2P	SCHNEIDER	A9F74210	
2KA5	1	LEAKAGE RELAY 25A 30mA			A9R41225 25A	
2F13	1	MINIATURE CIRCIUT BREAKER 16A	C60N 2P	SCHNEIDER	A9F74216	
2KA6	1	LEAKAGE RELAY 25A 30mA			A9R41225 25A	
2F14	1	MINIATURE CIRCIUT BREAKER 16A	C60N 2P	SCHNEIDER	A9F74216	
2KA7	1	LEAKAGE RELAY 25A 30mA			A9R41225 25A	
2F17	1	MINIATURE CIRCIUT BREAKER 16A	C60N 2P	SCHNEIDER	A9F74216	
2KA8	1	LEAKAGE RELAY 25A 30mA			A9R41225 25A	
2F18	1	MINIATURE CIRCIUT BREAKER 16A	C60N 2P	SCHNEIDER	A9F74216	
2KA9	1	LEAKAGE RELAY 25A 30mA			A9R41225 25A	
2F15	1	SIGORTALI KLEMENS 6mm2 6.3A	351 109	KLEMSAN	ASK 2S	
2F16	1	SIGORTALI KLEMENS 6mm2 6.3A	351 109	KLEMSAN	ASK 2S	
2H2	1	INDICATING LAMP WHITE	XB7-EV01MP	Telemecanique	XB7-EV01MP	
DR2	1	IMPACT CB. SWITCH 2P 16A	ITL	SCHNEIDER	A9C30812	
DR20	1	IMPACT CB. SWITCH 2P 16A	ITL	SCHNEIDER	A9C30812	
K2	1	LEAKAGE RELAY 25A 30mA			LC1D-09	
1F1	1	MINIATURE CIRCIUT BREAKER 16A	C60N 2P	SCHNEIDER	A9F74216	
1KA1	1	LEAKAGE RELAY 25A 30mA			A9R41225 25A	
1F2	1	MINIATURE CIRCIUT BREAKER 10A	C60N 2P	SCHNEIDER	A9F74210	
1KA2	1	LEAKAGE RELAY 25A 30mA			A9R41225 25A	
1F3	1	MINIATURE CIRCIUT BREAKER 32A	C60N 3P	SCHNEIDER	A9F74332	
1F4	1	MINIATURE CIRCIUT BREAKER 32A	C60N 3P	SCHNEIDER	A9F74332	
1F5	1	MINIATURE CIRCIUT BREAKER 32A	C60N 3P	SCHNEIDER	A9F74332	
1F6	1	MINIATURE CIRCIUT BREAKER 32A	C60N 3P	SCHNEIDER	A9F74332	
1F7	1	MINIATURE CIRCIUT BREAKER 16A	C60N 2P	SCHNEIDER	A9F74216	
1KA3	1	LEAKAGE RELAY 25A 30mA			A9R41225 25A	
1F8	1	MINIATURE CIRCIUT BREAKER 16A	C60N 2P	SCHNEIDER	A9F74216	
1KA4	1	LEAKAGE RELAY 25A 30mA			A9R41225 25A	
1F9	1	MINIATURE CIRCIUT BREAKER 32A	C60N 3P	SCHNEIDER	A9F74332	
1F10	1	MINIATURE CIRCIUT BREAKER 32A	C60N 3P	SCHNEIDER	A9F74332	
1F11	1	MINIATURE CIRCIUT BREAKER 32A	C60N 3P	SCHNEIDER	A9F74332	
1F12	1	MINIATURE CIRCIUT BREAKER 10A	C60N 2P	SCHNEIDER	A9F74210	
2KA5	1	LEAKAGE RELAY 25A 30mA			A9R41225 25A	
1F13	1	MINIATURE CIRCIUT BREAKER 16A	C60N 2P	SCHNEIDER	A9F74216	
2KA6	1	LEAKAGE RELAY 25A 30mA			A9R41225 25A	
1F14	1	MINIATURE CIRCIUT BREAKER 16A	C60N 2P	SCHNEIDER	A9F74216	
2KA7	1	LEAKAGE RELAY 25A 30mA			A9R41225 25A	

Bill of materials

Item	Amount	Designation	Type	Manufacturer	Article number	Note
1F18	1	MINIATURE CIRCIUT BREAKER 16A	C60N 2P	SCHNEIDER	A9F74216	
2KA9	1				A9R41225 25A	
1F15	1	SIGORTALI KLEMENS 6mm2 6.3A	351 109	KLEMSAN	ASK 2S	
1F16	1	SIGORTALI KLEMENS 6mm2 6.3A	351 109	KLEMSAN	ASK 2S	
1H1	1	INDICATING LAMP WHITE	XB7-EV01MP	Telemecanique	XB7-EV01MP	
DR1	1	IMPACT CB. SWITCH 2P 16A	ITL	SCHNEIDER	A9C30812	
DR10	1	IMPACT CB. SWITCH 2P 16A	ITL	SCHNEIDER	A9C30812	
K1	1				LC1D-09	
6F1	1	MINIATURE CIRCIUT BREAKER 16A	C60N 2P	SCHNEIDER	A9F74216	
6F2	1	MINIATURE CIRCIUT BREAKER 16A	C60N 2P	SCHNEIDER	A9F74216	
6F3	1	MINIATURE CIRCIUT BREAKER 16A	C60N 2P	SCHNEIDER	A9F74216	
6F4	1	MINIATURE CIRCIUT BREAKER 16A	C60N 2P	SCHNEIDER	A9F74216	
6F5	1	MINIATURE CIRCIUT BREAKER 16A	C60N 2P	SCHNEIDER	A9F74216	
6F6	1	MINIATURE CIRCIUT BREAKER 16A	C60N 2P	SCHNEIDER	A9F74216	
6F7	1	MINIATURE CIRCIUT BREAKER 16A	C60N 2P	SCHNEIDER	A9F74216	
6F8	1	MINIATURE CIRCIUT BREAKER 16A	C60N 2P	SCHNEIDER	A9F74216	
6F9	1	MINIATURE CIRCIUT BREAKER 16A	C60N 2P	SCHNEIDER	A9F74216	
6F10	1	MINIATURE CIRCIUT BREAKER 16A	C60N 2P	SCHNEIDER	A9F74216	
6F11	1	MINIATURE CIRCIUT BREAKER 10A	C60N 2P	SCHNEIDER	A9F74210	
6F12	1	MINIATURE CIRCIUT BREAKER 16A	C60N 2P	SCHNEIDER	A9F74216	
6F13	1	MINIATURE CIRCIUT BREAKER 16A	C60N 2P	SCHNEIDER	A9F74216	
6F14	1	MINIATURE CIRCIUT BREAKER 16A	C60N 2P	SCHNEIDER	A9F74216	
6F15	1	MINIATURE CIRCIUT BREAKER 16A	C60N 2P	SCHNEIDER	A9F74216	
6F19	1	MINIATURE CIRCIUT BREAKER 16A	C60N 2P	SCHNEIDER	A9F74216	
6F16	1	MINIATURE CIRCIUT BREAKER 16A	C60N 2P	SCHNEIDER	A9F74216	
6F17	1	SIGORTALI KLEMENS 6mm2 6.3A	351 109	KLEMSAN	ASK 2S	
F18	1	SIGORTALI KLEMENS 6mm2 6.3A	351 109	KLEMSAN	ASK 2S	
HE	1	INDICATING LAMP WHITE	XB7-EV01MP	Telemecanique	XB7-EV01MP	
DR1E	1	IMPACT CB. SWITCH 2P 16A	ITL	SCHNEIDER	A9C30812	
DR2E	1	IMPACT CB. SWITCH 2P 16A	ITL	SCHNEIDER	A9C30812	
DR3E	1	IMPACT CB. SWITCH 2P 16A	ITL	SCHNEIDER	A9C30812	
DR4E	1	IMPACT CB. SWITCH 2P 16A	ITL	SCHNEIDER	A9C30812	
DR5E	1	IMPACT CB. SWITCH 2P 16A	ITL	SCHNEIDER	A9C30812	
DR6E	1	IMPACT CB. SWITCH 2P 16A	ITL	SCHNEIDER	A9C30812	
DR7E	1	IMPACT CB. SWITCH 2P 16A	ITL	SCHNEIDER	A9C30812	
DR8E	1	IMPACT CB. SWITCH 2P 16A	ITL	SCHNEIDER	A9C30812	
DR9E	1	IMPACT CB. SWITCH 2P 16A	ITL	SCHNEIDER	A9C30812	
S3	1	YESIL ISIKLI YAYLI 230V LED BUTON	XB5-AW33M5	Telemecanique	XB5-AW33M5	
S4	1	YESIL ISIKLI YAYLI 230V LED BUTON	XB5-AW33M5	Telemecanique	XB5-AW33M5	
S1	1	YESIL ISIKLI YAYLI 230V LED BUTON	XB5-AW33M5	Telemecanique	XB5-AW33M5	
S2	1	YESIL ISIKLI YAYLI 230V LED BUTON	XB5-AW33M5	Telemecanique	XB5-AW33M5	
S5	1	YESIL ISIKLI YAYLI 230V LED BUTON	XB5-AW33M5	Telemecanique	XB5-AW33M5	
S6	1	YESIL ISIKLI YAYLI 230V LED BUTON	XB5-AW33M5	Telemecanique	XB5-AW33M5	
S7	1	YESIL ISIKLI YAYLI 230V LED BUTON	XB5-AW33M5	Telemecanique	XB5-AW33M5	
S8	1	YESIL ISIKLI YAYLI 230V LED BUTON	XB5-AW33M5	Telemecanique	XB5-AW33M5	
S9	1	YESIL ISIKLI YAYLI 230V LED BUTON	XB5-AW33M5	Telemecanique	XB5-AW33M5	

Bill of materials

Item	Amount	Designation	Type	Manufacturer	Article number	Note
E1	1	KIRMIZI ISIKLI YAYLI 230V LED BUTON	XB5-AW34M5	Telemecanique	XB5-AW34M5	
E2	1	KIRMIZI ISIKLI YAYLI 230V LED BUTON	XB5-AW34M5	Telemecanique	XB5-AW34M5	
E3	1	KIRMIZI ISIKLI YAYLI 230V LED BUTON	XB5-AW34M5	Telemecanique	XB5-AW34M5	
E4	1	KIRMIZI ISIKLI YAYLI 230V LED BUTON	XB5-AW34M5	Telemecanique	XB5-AW34M5	
E5	1	KIRMIZI ISIKLI YAYLI 230V LED BUTON	XB5-AW34M5	Telemecanique	XB5-AW34M5	
E6	1	KIRMIZI ISIKLI YAYLI 230V LED BUTON	XB5-AW34M5	Telemecanique	XB5-AW34M5	
E7	1	KIRMIZI ISIKLI YAYLI 230V LED BUTON	XB5-AW34M5	Telemecanique	XB5-AW34M5	
E8	1	KIRMIZI ISIKLI YAYLI 230V LED BUTON	XB5-AW34M5	Telemecanique	XB5-AW34M5	
E9	1	KIRMIZI ISIKLI YAYLI 230V LED BUTON	XB5-AW34M5	Telemecanique	XB5-AW34M5	
	L01	PANEL 500X800X250mm	IP54	GUL PANO	RAL7035	
	L02	PANEL 500X800X250mm	IP54	GUL PANO	RAL7035	
	L03	PANEL 500X800X250mm	IP54	GUL PANO	RAL7035	
	L04	PANEL 500X800X250mm	IP54	GUL PANO	RAL7035	
	L05	PANEL 500X800X250mm	IP54	GUL PANO	RAL7035	
	ELD	PANEL 500X700X250mm	IP54	GUL PANO	RAL7035	
1F19	1	MINIATURE CIRCIUT BREAKER 63A	C60N 3P	SCHNEIDER	A9F74363	
2F19	1	MINIATURE CIRCIUT BREAKER 63A	C60N 3P	SCHNEIDER	A9F74363	
4F19	1	MINIATURE CIRCIUT BREAKER 63A	C60N 3P	SCHNEIDER	A9F74363	
5F19	1	MINIATURE CIRCIUT BREAKER 63A	C60N 3P	SCHNEIDER	A9F74363	
6F19	1	MINIATURE CIRCIUT BREAKER 63A	C60N 3P	SCHNEIDER	A9F74363	

